



 **BOSCH**

# GLM 50-27 CG Professional

Robert Bosch Power Tools GmbH  
70538 Stuttgart • GERMANY

[www.bosch-professional.com](http://www.bosch-professional.com)

1 609 92A 8KF (2023.05) 0 / 253



1 609 92A 8KF



- en Original instructions
- zh 正本使用说明书
- zh 原始使用說明書
- ko 사용 설명서 원본
- th หนังสือคู่มือการใช้งานฉบับต้นแบบ
- id Petunjuk-Petunjuk untuk Penggunaan Original
- vi Bản gốc hướng dẫn sử dụng



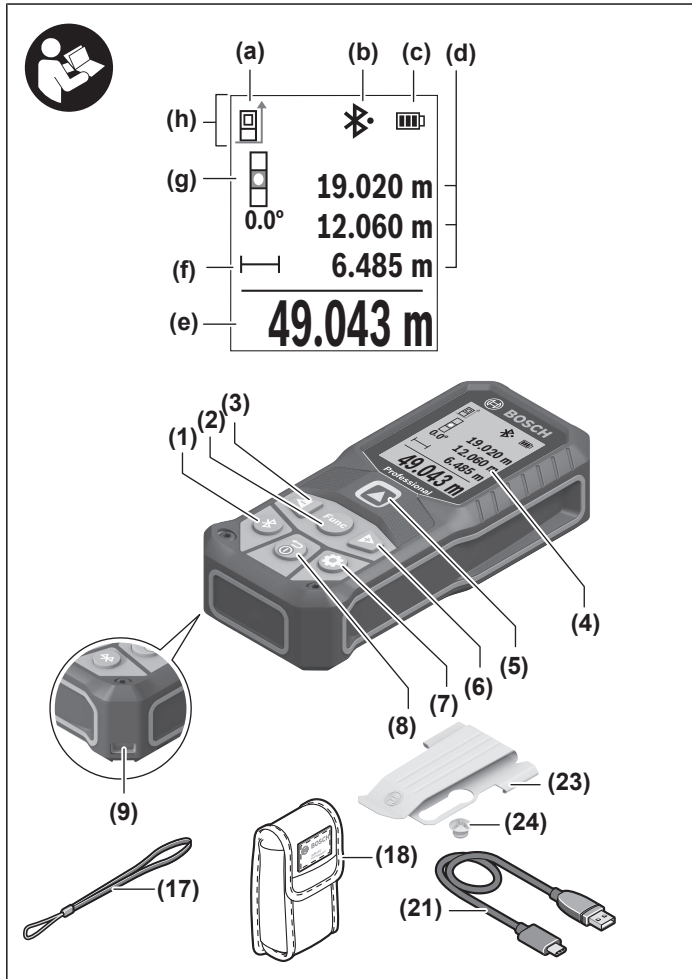

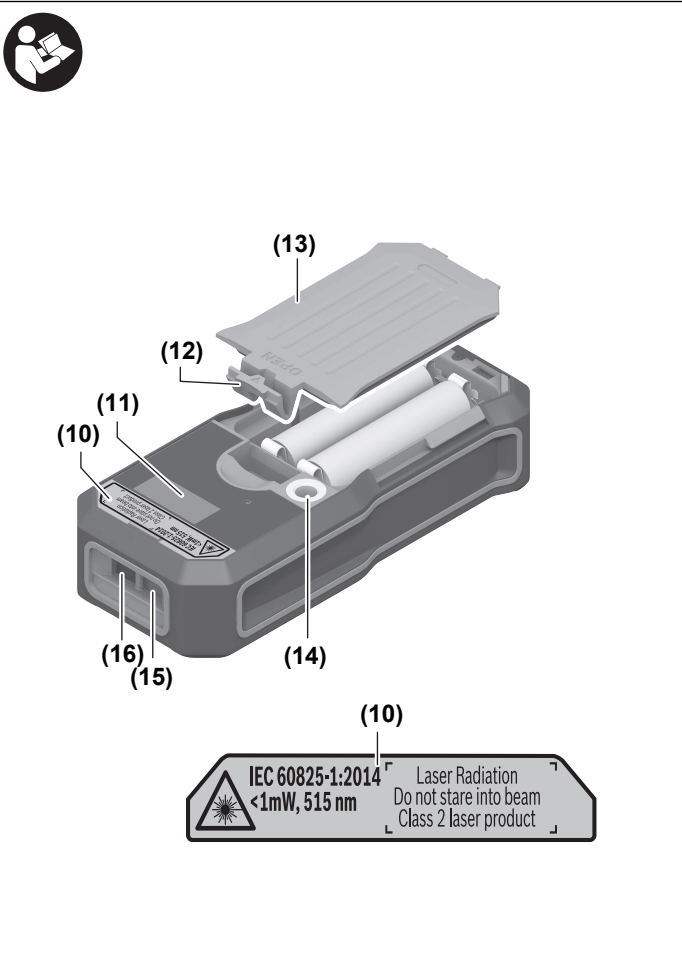

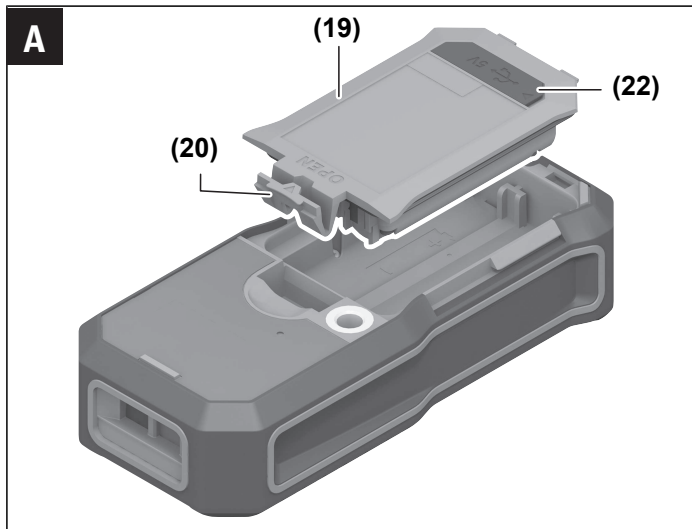

**B**

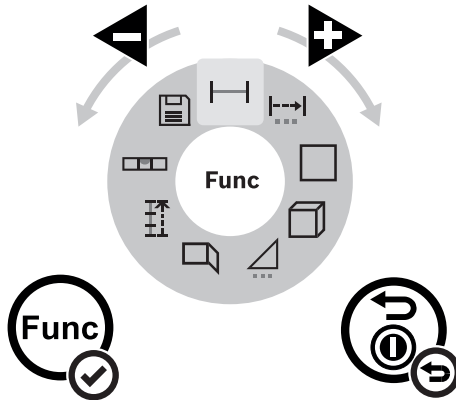
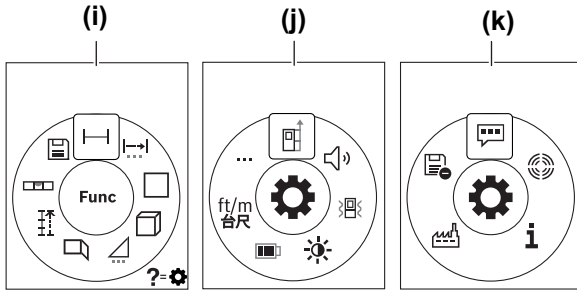



English .....	Page	8
中文 .....	页	42
繁體中文 .....	頁	76
한국어 .....	페이지	109
ไทย .....	หน้า	143
Bahasa Indonesia .....	Halaman	183
Tiếng Việt .....	Trang	218

# English

## Safety Instructions



All instructions must be read and observed in order for the measuring tool to function safely. The safeguards integrated into the measuring tool may be compromised if the measuring tool is not used in accordance with these instructions. Never make warning signs on the measuring

tool unrecognisable. **SAVE THESE INSTRUCTIONS FOR FUTURE REFERENCE AND INCLUDE THEM WITH THE MEASURING TOOL WHEN TRANSFERRING IT TO A THIRD PARTY.**

- ▶ **Warning!** If operating or adjustment devices other than those specified here are used or other procedures are carried out, this can lead to dangerous exposure to radiation.
- ▶ The measuring tool is delivered with a laser warning sign (marked in the illustration of the measuring tool on the graphics page).
- ▶ If the text of the laser warning label is not in your national language, stick the provided warning label in your national language over it before operating for the first time.



**Do not direct the laser beam at persons or animals and do not stare into the direct or reflected laser beam yourself.** You could blind somebody, cause accidents or damage your eyes.

- ▶ If laser radiation hits your eye, you must close your eyes and immediately turn your head away from the beam.
- ▶ Do not make any modifications to the laser equipment.
- ▶ Have the measuring tool serviced only by a qualified specialist using only original replacement parts. This will ensure that the safety of the measuring tool is maintained.
- ▶ Do not let children use the laser measuring tool unsupervised. They could unintentionally blind themselves or other persons.



- ▶ **Do not use the measuring tool in explosive atmospheres which contain flammable liquids, gases or dust.** Sparks may be produced inside the measuring tool, which can ignite dust or fumes.
- ▶ **Do not open the battery.** There is a risk of short-circuiting.
- ▶ **In case of damage and improper use of the battery, vapours may be emitted. The battery can set alight or explode.** Ensure the area is well ventilated and seek medical attention should you experience any adverse effects. The vapours may irritate the respiratory system.
- ▶ **If used incorrectly or if the battery is damaged, flammable liquid may be ejected from the battery. Contact with this liquid should be avoided. If contact accidentally occurs, rinse off with water. If the liquid comes into contact with your eyes, seek additional medical attention.** Liquid ejected from the battery may cause irritation or burns.
- ▶ **The battery can be damaged by pointed objects such as nails or screwdrivers or by force applied externally.** An internal short circuit may occur, causing the battery to burn, smoke, explode or overheat.
- ▶ **When the battery is not in use, keep it away from paper clips, coins, keys, nails, screws or other small metal objects that could make a connection from one terminal to another.** A short circuit between the battery terminals may cause burns or a fire.
- ▶ **Only use the battery with products from the manufacturer.** This is the only way in which you can protect the battery against dangerous overload.
- ▶ **Only charge the batteries using chargers recommended by the manufacturer.** A charger that is suitable for one type of battery may pose a fire risk when used with a different battery.



**Protect the battery against heat, e.g. against continuous intense sunlight, fire, dirt, water and moisture.** There is a risk of explosion and short-circuiting.



- ▶ **Do not use the laser goggles (accessory) as protective goggles.** The laser goggles make the laser beam easier to see; they do not protect you against laser radiation.
- ▶ **Do not use the laser goggles (accessory) as sunglasses or while driving.** The laser goggles do not provide full UV protection and impair your ability to see colours.
- ▶ **The measuring tool is equipped with a wireless interface. Local operating restrictions, e.g. in aeroplanes or hospitals, must be observed.**

The *Bluetooth*<sup>®</sup> word mark and logos are registered trademarks owned by Bluetooth SIG, Inc. and any use of such marks by Robert Bosch Power Tools GmbH is under license.

- ▶ **Caution!** When using the measuring tool with *Bluetooth*<sup>®</sup>, a fault may occur in other devices and systems, aeroplanes and medical devices (e.g. pacemakers, hearing aids). Also, damage to people and animals in the immediate vicinity cannot be completely excluded. Do not use the measuring tool with *Bluetooth*<sup>®</sup> in the vicinity of medical devices, petrol stations, chemical plants, areas with a potentially explosive atmosphere and in blasting areas. Do not use the measuring tool with *Bluetooth*<sup>®</sup> on aeroplanes. Avoid using the product near your body for extended periods.

## Safety instructions for power supply

- ▶ This power supply is not intended for use by children or persons with physical, sensory or mental limitations or a lack of experience or knowledge. This power supply can be used by children aged 8 or older and by persons who have physical, sensory or mental limitations or a lack of experience or knowledge if a person responsible for their safety supervises them or has instructed them in the safe operation of the power supply and they understand the associated dangers. Otherwise, there is a risk of operating errors and injuries.



**Do not expose the power supply to rain or wet conditions.** Water entering the power supply will increase the risk of electric shock.

- ▶ **Keep the power supply clean.** Dirt poses a risk of electric shock.
- ▶ **Always check the power supply before using it. Stop using the power supply if you discover any damage. Do not open the power supply yourself, and have it repaired only by Bosch or by an authorised after-sales service centre using only original replacement parts.** Damaged power supplies increase the risk of an electric shock.

## Product Description and Specifications

### Intended Use







The measuring tool is intended for measuring distances, lengths, heights, clearances and inclines, and for calculating areas and volumes.

The measuring tool is suitable for indoor use.

The measuring results can be transferred to other devices via *Bluetooth*<sup>®</sup>.

## Product Features

The numbering of the product features refers to the representation of the measuring tool in the images.

- (1)  Bluetooth® button
- (2)  Function button
- (3)  Minus button
- (4) Display
- (5)  Measuring button
- (6)  Plus button
- (7)  Basic settings button
- (8)  On/off/back button
- (9) Carrying strap mount
- (10) Laser warning label
- (11) Serial number
- (12) Battery compartment cover locking mechanism
- (13) Battery compartment cover
- (14) 1/4" tripod thread
- (15) Reception lens
- (16) Laser beam output
- (17) Carrying strap<sup>A)</sup>
- (18) Protective bag
- (19) Li-ion battery pack<sup>A)</sup>
- (20) Locking mechanism of the Li-ion battery pack<sup>A)</sup>
- (21) USB Type-C® cable<sup>A)B)</sup>
- (22) Flap for USB port<sup>A)</sup>
- (23) Belt clip<sup>A)</sup>

(24) Screw for belt clip<sup>A)</sup>

(25) Tripod<sup>A)</sup>

(26) Laser target plate<sup>A)</sup>

(27) Laser viewing glasses<sup>A)</sup>

A) **Accessories shown or described are not included with the product as standard. You can find the complete selection of accessories in our accessories range.**

B) USB Type-C® and USB-C® are trademarks of USB Implementers Forum.

### Display Elements

(a) Reference level of measurement

(b) *Bluetooth*® status

✳ *Bluetooth*® activated, connection not established

✳• *Bluetooth*® activated, connection established

(c) Battery indicator

(d) Measured value lines

(e) Result line

(f) Measuring function display

(g) Slope angle display

(h) Status bar

(i) Functions menu

(j) Basic settings menu

(k) Further basic settings menu

### Technical data

Digital laser measure	GLM 50-27 CG
Article number	<b>3 601 K72 U..</b>
Measuring range <sup>A)</sup>	0.05–50 m
Measuring range (unfavourable conditions) <sup>B)</sup>	0.05–20 m
Measuring accuracy <sup>A)</sup>	±1.5 mm

Digital laser measure	GLM 50-27 CG
Measuring accuracy (unfavourable conditions) <sup>B)</sup>	±3.0 mm
Smallest display unit	0.5 mm
<b>General</b>	
Operating temperature <sup>C)</sup>	-10 °C to +45 °C
Storage temperature	-20 °C to +70 °C
Relative air humidity max.	90 %
Max. altitude	2000 m
Pollution degree according to IEC 61010-1	2 <sup>D)</sup>
Laser class	2
Laser type	515 nm, < 1 mW
Divergence of the laser beam	< 1.5 mrad (full angle)
Automatic switch-off after approx.	
- Laser	20 s
- Measuring tool (without measurement) <sup>E)</sup>	5 min
<b>Indirect distance measurement and spirit level</b>	
Measuring range	0°-360° (4 × 90°)
<b>Grade measurement</b>	
Measuring range	0°-360° (4 × 90°)
Measuring accuracy <sup>F)</sup> <sup>G)</sup>	±0.2°
Smallest display unit	0.1°
Weight according to EPTA-Procedure 01:2014	0.17 kg
Protection rating	IP 65 (dust and splash-proof)
Dimensions	119 × 53 × 29 mm
Unit of measurement setting	m, ft, in
Batteries	2 × 1.5 V LR6 (AA)
<b>Battery pack (accessory)</b>	
Type	Li-ion
	BA 3.7V 1.0Ah A
Article number	<b>1 607 A35 17H</b>
USB charging connection	Type-C®

Digital laser measure	GLM 50-27 CG
Rated voltage	3.7 V ---
Capacity	1.0 Ah
Number of battery cells	1
Permitted charging temperature range	+10 °C to +35 °C
<b>Power supply</b>	
Output voltage	5.0 V ---
Minimum output current	500 mA
<b>Data transfer</b>	
Bluetooth®	Bluetooth® 4.2 (Low Energy) <sup>(1)</sup>
Operating frequency range	2402–2480 MHz
Max. transmission power	8 mW

- A) When measuring from the front edge of the measuring tool, this applies for high reflectivity of the target (e.g. a wall painted white), weak background lighting and a 20 °C operating temperature; a distance-dependent deviation of ±0.05 mm/m must additionally be factored in.
- B) When measuring from the front edge of the measuring tool, this applies for high reflectivity of the target (e.g. a wall painted white), strong background lighting, a 20 °C operating temperature and high elevation; a distance-dependent deviation of ±0.15 mm/m must additionally be factored in.
- C) In continuous measurement mode, the max. operating temperature is +40 °C.
- D) Only non-conductive deposits occur, whereby occasional temporary conductivity caused by condensation is expected.
- E) Bluetooth® deactivated
- F) At an operating temperature of 25 °C
- G) After user calibration at 0° and 90°; An additional grade error of ±0.01°/degree to 45° (max.) has to be taken into account. The left-hand side of the measuring tool serves as the reference level for grade measurement.
- H) When using Bluetooth® Low Energy devices, it may not be possible to establish a connection depending on the model and operating system. Bluetooth® tools must support the GATT profile.
- The serial number (**11**) on the type plate is used to clearly identify your measuring tool.

## Inserting/Changing the Battery

Using alkali-manganese or nickel metal hydride rechargeable batteries (especially at low operating temperatures) is recommended for operation of the measuring tool.

With 1.2 V rechargeable batteries, more measurements may be possible than with 1.5 V batteries, depending on the capacity.

- » Open the battery compartment cover.
- » Insert the batteries/rechargeable batteries.

**i** Always replace all the batteries/rechargeable batteries at the same time. Only use batteries/rechargeable batteries from the same manufacturer and which have the same capacity.

**i** When inserting the batteries, ensure that the polarity is correct according to the illustration on the inside of the battery compartment.

When the state of charge of the non-rechargeable batteries or rechargeable batteries is low, a request to activate the battery saver mode will appear on the display. When the battery saver mode is activated, the battery runtime will be extended and the battery symbol on the display will have a yellow outline. (see "Switching On and Off Battery Saver Mode" , page 21)

When the empty battery symbol first appears on the display, only a limited number of measurements are still possible.

When the battery symbol is empty and flashes red, no further measurements are possible. Replace the batteries or rechargeable batteries.

► **Take the batteries out of the measuring tool when you are not using it for a prolonged period of time.** The batteries can corrode and self-discharge during prolonged storage.

**i** Never store the measuring tool without an inserted battery compartment cover **(13)** or lithium-ion battery pack **(19)** (accessory), particularly in dusty or humid environments.

## Lithium-ion battery pack (accessory)

### Inserting/changing the lithium-ion battery pack (accessory)

- » Insert the lithium-ion battery pack **(19)** (accessory).
- » To remove the lithium-ion battery pack **(19)** (accessory), press the locking mechanism **(20)** and take the lithium-ion battery pack out. (see Fig. A, page 4)

### Charging the lithium-ion battery pack (accessory)

► **For charging, use the recommended USB power supply unit or a power supply unit whose output voltage and minimum output current comply with the requirements**

in the "Technical Data" section. Observe the operating manual of the USB power supply unit.

Recommended power supply unit: See "Technical Data".

- ▶ **Pay attention to the mains voltage.** The voltage of the power source must match the voltage specified on the rating plate of the power adaptor. Power adaptors marked with 230 V can also be operated with 220 V.

**i** Lithium-ion rechargeable batteries are supplied partially charged according to international transport regulations. To ensure full rechargeable battery capacity, fully charge the rechargeable battery before using your tool for the first time.

The USB port for connecting the USB cable **(21)** and the charging indicator light can be found under the flap for the USB port **(22)** on the lithium-ion battery pack **(19)** (accessory).

» Open the flap of the USB port **(22)**.

» Connect the USB cable **(21)**.

During the charging process, the battery indicator on the display may differ from the actual state of charge of the lithium-ion battery pack **(19)** (accessory).

During charging, the charging indicator light lights up yellow.

When the lithium-ion battery pack **(19)** (accessory) is fully charged, the charging indicator light will light up green.

A red charging indicator light indicates that the charging voltage or charging current is unsuitable.

## Operation



### Starting Operation

- ▶ **Never leave the measuring tool unattended when switched on, and ensure the measuring tool is switched off after use.** Others may be dazzled by the laser beam.
- ▶ **Protect the measuring tool from moisture and direct sunlight.**
- ▶ **Do not expose the measuring tool to any extreme temperatures or variations in temperature.** For example, do not leave it in a car for extended periods of time. In case of large variations in temperature, allow the measuring tool to adjust to the ambient temperature before putting it into operation. The precision of the measuring tool may be compromised if exposed to extreme temperatures or variations in temperature.



- ▶ **Avoid substantial knocks to the measuring tool and avoid dropping it.** After strong external influences on the measuring tool, you should always carry out an accuracy check (see "Accuracy Check", page 36) before further work.

### Switching On and Off

- » Press the ▲ button to switch the measuring tool and the laser on.  
You can also switch on the measuring tool without the laser by pressing the  button.
- » Press and hold the  button to switch off the measuring tool.  
The measured values and device settings in the memory are retained.

### Measuring Process

When switching on for the first time, the measuring tool will be in the length measurement function. When switching on every subsequent time, the measuring tool will be in the measuring function that was last used.

Three settings are available for the reference level of the measurement. (see "Selecting the Reference Level", page 18)

- » Apply the measuring tool to the point at which you want to start the measurement (e.g. wall).
- » If you have switched on the measuring tool with the  button, then briefly press the ▲ button to switch on the laser.
- » Press the ▲ button to start the measurement.

Once the measurement process is complete, the laser beam will switch off. For a further measurement, repeat this process.

Measured values or end results can be added or subtracted.

The measured value typically appears within 0.5 s and at the latest after approx. 4 s.

The duration of the measurement depends on the distance, the lighting conditions and the reflective properties of the target surface. Once the measurement process is complete, the laser beam will automatically switch off.

-  The measuring tool must not be moved during a measurement (with the exception of the continuous measurement and grade measurement functions). Therefore, place the measuring tool, as far as this is possible, against or on a firm stop or supporting surface.

-  The reception lens **(15)** and the laser beam output **(16)** must not be covered during the measuring process.

### Influences on the Measuring Range

The measuring range depends on the lighting conditions and the reflective properties of the target surface.

For better visibility of the laser beam in bright extraneous light, use the laser viewing glasses **(27)** (accessory) and the laser target plate **(26)** (accessory), or shade the target surface.

### Influences on the Measurement Result



Due to physical effects, incorrect measurements are possible when measuring on various surfaces. These include:

- Transparent surfaces (e.g. glass, water)
  - Reflective surfaces (e.g. polished metal, glass)
  - Porous surfaces (e.g. insulation materials)
  - Structured surfaces (e.g. roughcast, natural stone)
- If necessary, use the laser target plate **(26)** (accessory) on these surfaces.

Incorrect measurements are also possible on slanted target surfaces.

Likewise, layers of air with different temperatures or indirectly received reflections can influence the measured value.

### Navigation in the Menus

In the menus, you can switch to the right with the  button and to the left with the  button.

To confirm a selection, press the  button or the  button.

Press the  button to exit the menu.

### Selecting the Reference Level

For the measurement, you can select from various reference levels:







The rear edge of the measuring tool (e.g. when placing against walls)



The centre of the tripod thread **(14)** (e.g. for tripod measurements)













The front edge of the measuring tool (e.g. when measuring from a table edge)







- » Press the  button to open the **Basic settings** menu.
- » Select .
- » Use the  button or  button to select the required reference level.
- » To confirm the selection, press the  button.

Every time the measuring tool is switched on, the last selected reference level is preset. Subsequent alteration of the reference level of measurements that have already been taken (e.g. upon display of measured values in the measured value list) is not possible.

## Basic Settings Menu









In the **Basic settings** menu, you can find the following basic settings:

-  Changing the reference level (see "Selecting the Reference Level", page 18)
-  Switching audio signals on and off
-  Switching Vibration on and off
-  Setting display brightness
-  Switching on and off battery saver mode
-  Changing the unit of measurement
-  Setting the language
-  Grade measurement calibration (see "Accuracy Check", page 36)
-  Calling up Device Information
-  Factory settings
-  Deleting Memory

- » Press the  button to open the **Basic settings** menu.
- » Use the  button or  button to select the required setting.
- » To confirm a selection, press the  button or the  button.
- » To exit the **Basic settings** menu, briefly press the  button.

### Switching Audio Signals On and Off

The sound is switched on by default.









- » Press the  button to call up the **Basic settings**  menu.
- » Select .
- » To change the selection, press the  button or the  button.
- » To confirm the selection, press the  button or the  button.
- » To exit the **Basic settings**  menu, briefly press the  button.

The selected setting remains saved after you switch off the measuring tool.

### Switching Vibration On and Off

The vibration function is switched on by default.







The vibration function of the measuring tool can be a useful aid, for example in noisy environments. Two short vibrations indicate a successful measurement; one long vibration indicates a measurement error.

- » Press the  button to call up the **Basic settings**  menu.
- » Select .
- » To change the selection, press the  button or the  button.
- » To confirm the selection, press the  button or the  button.
- » To exit the **Basic settings**  menu, briefly press the  button.

The selected setting remains saved after you switch off the measuring tool.

### Setting Display Brightness

The brightness of the display can be adjusted to the environmental conditions with several settings.









- » Press the  button to call up the **Basic settings**  menu.
- » Select .
- » To change the selection, press the  button or the  button.
- » To confirm the selection, press the  button or the  button.

- » To exit the **Basic settings**  menu, briefly press the  button.

The selected setting remains saved after you switch off the measuring tool.

### Switching On and Off Battery Saver Mode









Battery saver mode is switched off by default. When battery saver mode is switched on, sound and vibration are deactivated and the display brightness is reduced. This extends the battery runtime.

- » Press the  button to call up the **Basic settings**  menu.
- » Select .
- » To change the selection, press the  button or the  button.
- » To confirm the selection, press the  button or the  button.
- » To exit the **Basic settings**  menu, briefly press the  button.

The selected setting remains saved after you switch off the measuring tool.

### Changing the Unit of Measurement

Basic setting is the unit of measurement "m" (metres). Six different units of measurement are available. Set the appropriate unit of measurement for your purposes.

- » Press the  button to call up the **Basic settings**  menu.
- » Select .
- » To change the selection, press the  button or the  button.
- » To confirm the selection, press the  button or the  button.
- » To exit the **Basic settings**  menu, briefly press the button .









The selected setting remains saved after you switch off the measuring tool.

### Setting the Language

When switching on the measuring tool for the first time, you will be prompted to set your preferred language for the display text.

You can change the selected language at any time.







- » Press the  button to call up the **Basic settings**  menu.

- » Select  for further settings.
- » Select .
- » To change the selection, press the  button or the  button.
- » To confirm the selection, press the  button or the  button.
- » To exit the **Basic settings**  menu, briefly press the  button.

The selected setting remains saved after you switch off the measuring tool.









### Device Information

Here you will find information about the measuring tool, such as the serial number, software version and licences.



- » Press the  button to call up the **Basic settings**  menu.
- » Select  for further settings.
- » Select .
- » To exit the **Basic settings**  menu, briefly press the  button.







### Factory Reset

This function is used to reset the measuring tool to factory settings. After carrying out a reset, you will be prompted to set your preferred language for the display.

- » Press the  button to call up the **Basic settings**  menu.
- » Select  for further settings.
- » Select .
- » To reset the measuring tool, select  and confirm with the  button or the  button.
- » To exit the **Basic settings**  menu, briefly press the  button.

### Deleting Memory













- » Press the  button to call up the **Basic settings**  menu.





- » Select  for further settings.
- » Select .
- » To delete the memory, select  with the  button or with the  button and confirm with the  button or the  button.  
All measured values are deleted.

## Measuring functions

### Selecting/Changing Measuring Function

You will find the following functions in the Functions menu:

-  Length measurement
-  Continuous measurement
-  Area measurement
-  Volume measurement
-  Indirect distance measurement
  -  Indirect height measurement
  -  Double indirect height measurement
  -  Indirect length measurement
-  Wall area measurement
-  Stake-out function
-  Grade measurement/digital spirit level
-  Memory function

- » Press the  button to open the **Functions** menu.
- » Use button  or button  to select the required measuring function.
- » To confirm the selection, press the  button or the  button.

## Integrated help function ?

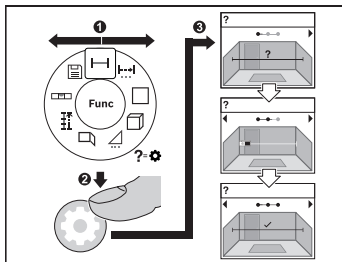

The help function integrated into the measuring tool offers animations for all measuring functions/measuring processes.

- » Open the **Functions** menu.
- » Select the required function with the button or with the button and press the button.

The animation showing the detailed procedure for the selected measuring func-

tion is displayed.

- » Press the button or the button to display the next or the previous step.

## Length Measurement

- » Press the button to open the **Functions** menu.
- » Select the length measurement and confirm the selection with the button.
- » Briefly press the button to switch on the laser.
- » Press the button to start the measurement.

The measured value is displayed in the result line **(e)** at the bottom of the display.



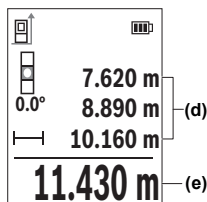



- » Repeat the above-mentioned steps for each subsequent measurement.



If several length measurements are taken in a row, the results of the last measurements are displayed in the measured value lines **(d)**. The last measured value is at the bottom of the display, the penultimate measured value is above it, and so on.



## Area Measurement

- » Press the  button to open the **Functions** menu.
- » Select area measurement  and confirm the selection with the .
- » Briefly press the  button to switch on the laser.
- » Press the  button to start the first measurement, e.g. the length of a room.
- » Press the  button to start the second measurement, e.g. the width of a room.

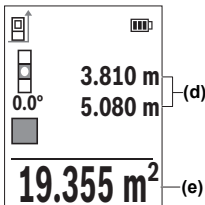

After the second measurement has been completed, the area will be automatically calculated and displayed. The result is displayed in the result line **(e)**. The individual measured values are in the measured value lines **(d)**.

## Continuous Measurement



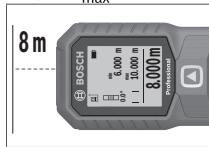

During continuous measurement, the measured value is continually updated. You can, for example, move a required distance away from a wall while reading off the current distance at all times.

Three functions are available for continuous measurement, for each of which the measurement is depicted differently in the display:

### Min/max



The smallest and the largest measured value are permanently shown on the display.

- » Press the  button to open the **Functions** menu.
- » Select min/max  in the continuous measurement  menu item and confirm the selection with the .
- » Briefly press the  button to switch on the laser.
- » Move the measuring tool until the required distance is displayed in the result line.

You can interrupt the continuous measurement by briefly pressing the  button.

» Press the ▲ button again to continue the continuous measurement.

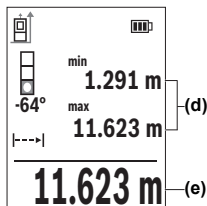

The current measured value is displayed in the result line **(e)**, and the maximum and the minimum measured value in the measured value lines **(d)**.

### Large figures 00<sup>+</sup>

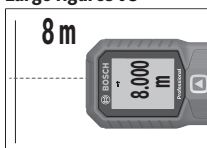

The measured value is displayed in large figures for better readability.

### Tape measure 0<sub>ref</sub>

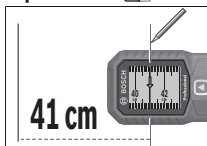

The distance is visually displayed, as with a tape measure.

**i** In the tape measure function, the reference level is the marking shown in the display. The reference level is not the edge of the measuring tool.

Continuous measurement switches off automatically after 4 min.

### Volume Measurement

- » Press the **Func** button to open the **Functions** menu.
- » Select volume measurement  and confirm the selection with the **Func** button.
- » Briefly press the ▲ button to switch on the laser.
- » Press the ▲ button to start the first measurement, e.g. the length of a room.

» Press the ▲ button to start the second measurement, e.g. the width of a room.

» Press the ▲ button to start the third measurement, e.g. the height of a room.

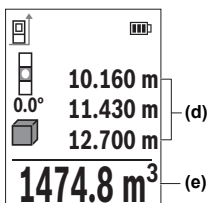

After the third measurement has been completed, the volume will be automatically calculated and displayed. The result is displayed in the result line **(e)**. The individual measured values are in the measured value lines **(d)**.

### Indirect distance measurement



Indirect distance measurement is used to measure distances that cannot be measured directly because an obstacle would obstruct the laser beam or no target surface is available as a reflector. This measuring procedure can only be used in a vertical direction. Any deviation in a horizontal direction leads to measuring errors.

Indirect distance measurement is always less accurate than direct distance measurement. For application-related reasons, measuring errors can be greater than with direct distance measurement. To improve measuring accuracy, the use of a tripod (accessory) is recommended.

 When using a tripod, observe the set reference level. (see "Selecting the Reference Level", page 18)

The laser beam remains switched on between the individual measurements.

For indirect distance measurement, **3** measuring functions are available, with which different sections can be respectively determined:



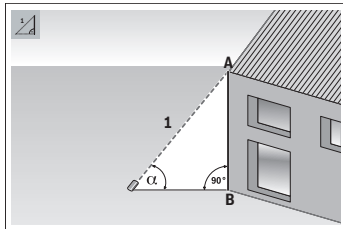

-  Indirect height measurement
-  Double indirect height measurement
-  Indirect length measurement

### Indirect Height Measurement



With indirect height measurement, you can determine distance **AB** by measuring distance **1**. The measuring tool calculates the required height **AB** from angle  $\alpha$  and distance **1**.

Correct results are achieved only when the right angle required for the respective measurement is exactly adhered to.

- » Press the **Func** button to open the **Functions** menu.
- » Select indirect distance measurement  and confirm the selection with the **Func** button.
- » Select indirect height measurement  and confirm the selection with the **Func** button.
- » Briefly press the  button to switch on the laser.
- » Place the measuring tool at the height of the lower measuring point **B**.
- » Tilt the measuring tool so that the laser is pointed at the upper measuring point **A**.
- » Press the  button to start the measurement.





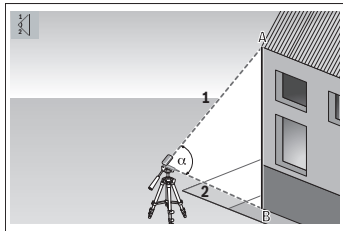



After the measurement has been completed, the height will be automatically calculated and displayed in the result line **(e)**. The measured values for section **1** and angle  $\alpha$  are in the measured value lines **(d)**.

### Double Indirect Height Measurement









With double indirect height measurement, you can determine distance **AB** by measuring distances **1** and **2**. The measuring tool calculates the required height **AB** from angle  $\alpha$  and distances **1** and **2**.

The use of a tripod is recommended for this measurement.

- » Press the  button to open the **Functions** menu.
- » Select indirect distance measurement  and confirm the selection with the  button.
- » Select double indirect height measurement  and confirm the selection with the  button.
- » Briefly press the  button to switch on the laser.
- » Tilt the measuring tool so that the laser is pointed at the upper measuring point **A**.
- » Press the  button to start the first measurement.
- » Tilt the measuring tool so that the laser is pointed at the lower measuring point **B**. Do not change the position of the measuring tool when doing so.
- » Press the  button to start the second measurement.

After the measurement has been completed, the height will be automatically calculated and displayed in the result line **(e)**. The measured values for section **1**, section **2** and angle  $\alpha$  are in the measured value lines **(d)**.

#### Indirect Length Measurement

- » Press the  button to open the **Functions** menu.
- » Select indirect distance measurement  and confirm the selection with the  button.
- » Select indirect length measurement  and confirm the selection with the  button.
- » Put the measuring tool on the starting point **A** of the required distance **AB**.
- » Tilt the measuring tool so that the laser is aligned with the level of end point **B**.
- » Press the  button to start the measurement.

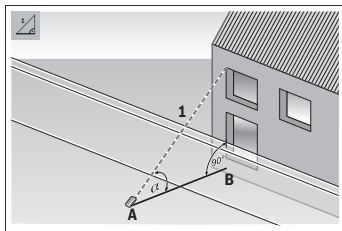

With indirect length measurement, you can determine distance **AB** by measuring distance **1**. The measuring tool calculates the required length **AB** from angle  $\alpha$  and distance **1**.

After the measurement has been completed, the length will be automatically calculated and displayed in the result line **(e)**. The measured values for section **1** and angle  $\alpha$  are in the measured value lines **(d)**.

### Wall Area Measurement

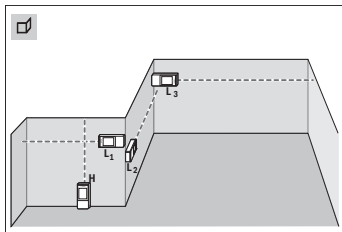

The wall area measurement is used to determine the sum of multiple individual areas with a common height. The requirement for a correct area calculation is that the first measured length (for example the ceiling height **H**) is identical for all sub-areas. In the illustrated example, the total area of several walls that have the same ceiling height **H** but different lengths **L** is to be determined.

- » Press the **Func** button to open the **Functions** menu.
- » Select wall area measurement  and confirm the selection with the **Func** button.
- » Measure the ceiling height **H** as for a length measurement.

The measured value is displayed in the top measured value line. The laser remains switched on.

- » Afterwards measure the length **L1** of the first wall.

The area is automatically calculated and displayed in the result line. The last measured value for length can be found in the bottom measured value line. The laser remains switched on.

- » Now measure the length **L2** of the second wall.

You can measure any number of lengths **LX**, which will be automatically added and multiplied by the height **H**.

The individual measured value displayed in the measured value line (**d**) is added to the length **L1**. The sum of the two lengths (displayed in the middle measured value line (**d**)) is multiplied by the saved height **H**. The total area value is shown in the result line (**e**) at the bottom of the display.





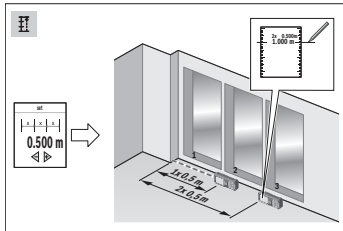

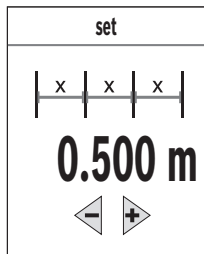

### Stake-Out Function

-  In the stake-out function, the reference level is the marking shown in the display. The reference level is not the edge of the measuring tool.



The stake-out function repeatedly measures a defined length (distance). These lengths can be transferred to a surface, for example to enable material to be cut into pieces of equal length or to install stud walls in a dry-wall construction. The minimum adjustable length is 0.1 m and the maximum length is 50 m.



- » Press the  button to open the **Functions** menu.
- » Select stake-out function  and confirm the selection with the .
- » Use the  button or the  button to set the required length.  
Press and hold the  button or the  button to change the length by larger increments.
- » Press the  button to start the stake-out function and distance yourself slowly from the starting point.

The measuring tool continuously measures the distance to the starting point. The defined length and the current measured value are thereby displayed. The lower or upper arrow displays the shortest distance to the next or previous marking.





The left factor specifies how many times the defined length has already been reached. The green lines on either side of the display indicate that a length has been reached for marking purposes.



Blue lines and blue text indicate the actual value when the reference is outside the display.

### Grade Measurement/Digital Spirit Level

The digital spirit level is used to check the horizontal or vertical alignment of an object (e.g. washing machine, refrigerator, etc.). Grade measurement is used to measure a slope or incline (e.g. of stairs, railings, when fitting furniture, laying pipes, etc.). The measuring tool automatically switches between the two functions when you change the position of the measuring tool.

- » Press the  button to open the **Functions** menu.
- » Select grade measurement/digital spirit level  and confirm the selection with the  button.



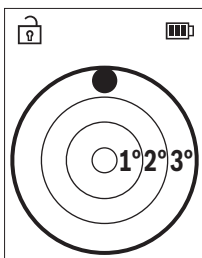

The bottom of the measuring tool is used as the reference level for the digital spirit level.

- » To use the digital spirit level, place the measuring tool with the rear side on the surface to be measured.

You can freeze the measured value by pressing the ▲ button.

- » When the inclination exceeds 3°, the ball in the display lights up red.

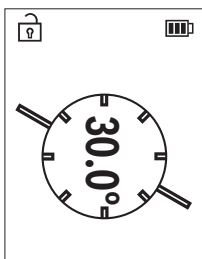





The left-hand side of the measuring tool serves as the reference level for grade measurement. If the display flashes during measurement, the measuring tool has been tipped too heavily to the side.

- » To use the grade measurement, place the measuring tool with one side on the object to be measured.

You can freeze the measured value by pressing the ▲ button.

## Memory Function



The value or end result of each completed measurement is automatically saved. The last **30** values (measured values or end results) are saved. If the memory is full, the oldest value will be overwritten. The oldest value is at position 1 in the memory, the newest value at position **30** (for **30** available memory values).

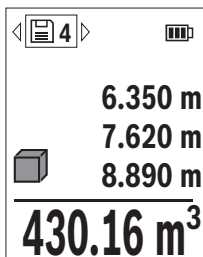

- » Press the  button to open the **Functions** menu.
- » Select the memory function  and confirm the selection with the  button.  
The last value will be displayed.
- » Press the  button or  button to scroll through the saved values.



The number of the memory value is shown at the top of the display, and the symbol of the corresponding measuring function is shown on the left. If there is no value available in the memory, "0.000" is shown at the bottom of the display and "0" at the top.

### Deleting Memory Values

- » To delete the displayed value, press the  button.
- » Confirm with the  button.

To delete all saved values, select the **Delete memory** menu item in the **Basic settings**  menu. (see "Deleting Memory " , page 22)

### Adding/Subtracting Values

#### Adding Values During Length Measurement

- » Select the length measurement function.
- » Take the first measurement.
- » Press the  button.
- » Take the second measurement.

As soon as the second measurement has been completed, the result of the second measurement is displayed in the measured value lines **(d)** and the end result in the result line **(e)**.

#### Adding Values During Area and Volume Measurement

- » Select the area measurement or volume measurement function.
- » Take the first area measurement or volume measurement.

» Press the  button.

» Take the second area measurement or volume measurement.

As soon as the second or third measurement has been completed, the area or volume is automatically calculated and displayed. The result is displayed in the result line **(e)**. The individual measured values are in the measured value lines **(d)**.

» Press the  button to show the end result of the addition.

The end result is displayed in the result line **(e)**. The results of the individual area or volume measurements are in the measured value lines **(d)**.

### Subtracting Values

» Press the  button to subtract values. The subsequent steps are the same as for the section on "adding values".

### Deleting Measured Values

You can delete the most recently recorded measured value in all measuring functions by briefly pressing button .

By pressing the  button briefly multiple times, the measured values are deleted in reverse order.

### Bluetooth® interface

#### Transmitting data to other devices

The measuring tool is fitted with a *Bluetooth*® module which enables wireless data transfer to certain mobile devices with a *Bluetooth*® interface (e.g. smartphone, tablet).

Information about the system requirements for a *Bluetooth*® connection can be found on the Bosch website at [www.bosch-pt.com](http://www.bosch-pt.com)

#### ► Further information can be found on the Bosch product page.

When transmitting data by means of *Bluetooth*®, time lags may occur between the mobile device and the measuring tool. This can be due to the distance between the two devices or the measurement object itself.

#### Activating the *Bluetooth*® interface for transmitting data to a mobile device

✓ Ensure that the *Bluetooth*® interface is activated on your mobile device.

» Press the  button to call up the *Bluetooth*® menu.

- » Press the  button again to activate the *Bluetooth*® interface.

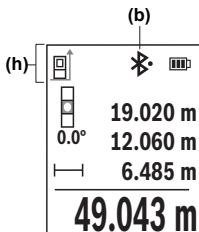



The connection status and the active connection **(b)** are displayed in the status bar **(h)** of the measuring tool.

Bosch apps are available to expand the range of functions. These can be downloaded in the respective app stores, depending on the device.

The connection between mobile device and measuring tool is established after the Bosch application has started. If multiple active measuring tools are found, select the appropriate measuring tool using the serial number. You can find the serial number **(11)** on your measuring tool's type plate.

### Deactivating the *Bluetooth*® interface

- » Press the  button to bring up the *Bluetooth*® menu and press the  button again to deactivate the *Bluetooth*® interface.

## Accuracy Check



Regularly check the accuracy of the grade measurement and distance measurement.

### Accuracy Check and Calibration of the Grade Measurement

- » To do this, lay the measuring tool on a table and measure the inclination.
- » Turn the measuring tool by 180° and measure the inclination again.

The difference between the displayed values must not exceed 0.3°.

In case of greater deviation, the measuring tool must be recalibrated.

- » Press the  button to open the **Basic settings** menu.
- » Select  and confirm the selection with the  button.
- » Follow the instructions on the display.

 After strong temperature changes and after knocks, we recommend an accuracy check and, if necessary, calibration of the measuring tool. After a temperature variation, the measuring tool must adjust to the ambient temperature for a while before calibration is performed.

### Accuracy Check of the Distance Measurement

For the accuracy check, the measurement should be taken under favourable conditions, i.e. the measuring section should be indoors and the target surface for the measurement should be smooth and reflect well (e.g. a white-painted wall).

- » Select a measuring section of approx. **3 to 10 m** long, the length of which you know exactly (e.g. room width, doorway).
- » Measure the section 10 times in succession.

The deviation of individual measurements from the exact known value may be maximum  $\pm 2$  mm throughout the entire measuring section under favourable conditions.

Log the measurements, so that you can compare their accuracy at a later point of time.

### Working with the Tripod (Accessory)

The use of a tripod is helpful, particularly for greater distances.

- » Place the measuring tool with the 1/4" thread (**14**) on the quick-release plate of the tripod (**25**) or of a commercially available camera tripod.
- » Tighten the measuring tool with the quick-release plate locking screw.
- » Set the reference level for measurements with a tripod (see "Selecting the Reference Level", page 18).

## Belt clip

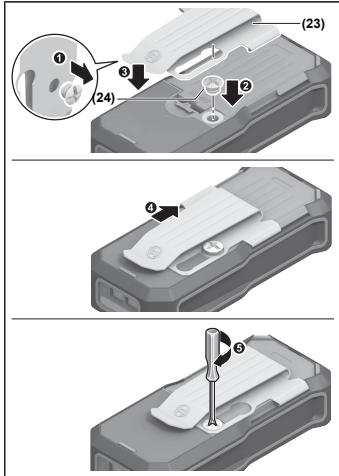

With the belt clip **(23)**, the measuring tool can be conveniently secured to your belt. Follow the steps in the figure to attach the belt clip to the measuring tool.

## Error Message

If a measurement cannot be performed correctly, the error message **Error** will appear in the display.

- » Try to perform the measuring process again.
- » If the error message appears again, switch the measuring tool off and back on, and start the measurement again.



The measuring tool monitors correct operation in every measurement. If a defect is detected, the display will indicate only the symbol shown opposite and the measuring tool switches itself off. In this case, have the measuring tool checked by an after-sales service agent for Bosch power tools.

## Maintenance and Service

### Maintenance and Cleaning

Only store and transport the measuring tool in the protective bag provided.

Keep the measuring tool clean at all times.

Never immerse the measuring tool in water or other liquids.

Wipe off any dirt using a damp, soft cloth. Do not use any detergents or solvents.

Take particular care of the reception lens **(15)**, which must be handled with the same level of care you would give to a pair of glasses or a camera lens.

If the measuring tool needs to be repaired, send it off in the protective bag **(18)**.

### After-Sales Service and Application Service

Our after-sales service responds to your questions concerning maintenance and repair of your product as well as spare parts. You can find explosion drawings and information on spare parts at: **[www.bosch-pt.com](http://www.bosch-pt.com)**

The Bosch product use advice team will be happy to help you with any questions about our products and their accessories.

In all correspondence and spare parts orders, please always include the 10-digit article number given on the nameplate of the product.

#### Malaysia

Robert Bosch Sdn. Bhd.(220975-V) PT/SMY

No. 8A, Jalan 13/6

46200 Petaling Jaya

Selangor

Tel.: (03) 79663194

Toll-Free: 1800 880188

Fax: (03) 79583838

E-Mail: [kiathoe.chong@my.bosch.com](mailto:kiathoe.chong@my.bosch.com)

[www.bosch-pt.com.my](http://www.bosch-pt.com.my)

#### You can find further service addresses at:

[www.bosch-pt.com/serviceaddresses](http://www.bosch-pt.com/serviceaddresses)

### Transport

The recommended lithium-ion batteries are subject to legislation on the transport of dangerous goods. The user can transport the batteries by road without further requirements.

When shipping by third parties (e.g.: by air transport or forwarding agency), special requirements on packaging and labelling must be observed. For preparation of the item being shipped, consulting an expert for hazardous material is required.

Dispatch battery packs only when the housing is undamaged. Tape or mask off open contacts and pack up the battery in such a manner that it cannot move around in the packaging. Please also observe the possibility of more detailed national regulations.

## Disposal



Measuring tools, rechargeable/non-rechargeable batteries, accessories and packaging should be sorted for environmental-friendly recycling.



Do not dispose of the measuring tools or battery packs/batteries with household waste.

## Battery packs/batteries:

### Li-ion:

Please observe the notes in the section on transport (see "Transport", page 39).

## Accessories

You can find the accessory on the Bosch website via the link given



BA 3.7V 1.0Ah A (19)  
1 608 M00 C5D



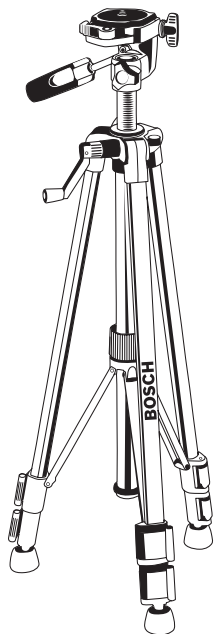

BT 150 tripod **(25)**

0 601 096 B00

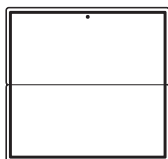

Laser target plate **(26)**

2 607 001 391



Laser viewing glasses (green) (27)  
1 608 M00 05J

## 中文

### 安全规章



必须阅读并注意所有说明，以安全可靠地操作测量仪。如果不按照给出的说明使用测量仪，可能会影响集成在测量仪中的保护功能。测量仪上的警戒牌应保持清晰可读的状态。请妥善保管本说明书，并在转交测量仪时将本说明书一起移交。

- ▶ 小心 – 如果使用了与此处指定的操作或校准设备不同的设备，或执行了不同的过程方法，可能会导致危险的光束泄露。
- ▶ 本测量仪交付时带有一块激光警戒牌（在测量仪示意图的图形页中标记）。
- ▶ 如果激光警戒牌的文字并非贵国语言，则在第一次使用前，将随附的贵国语言的贴纸贴在警戒牌上。



不得将激光束指向人或动物，请勿直视激光束或反射的激光束。可能会致人炫目、引发事故或损伤眼睛。

- ▶ 如果激光束射向眼部，必须有意识地闭眼，立即从光束位置将头移开。
- ▶ 请不要对激光装置进行任何更改。

- ▶ 仅允许由具备资质的专业人员使用原装备件修理测量仪。如此才能够确保测量仪的安全性能。
- ▶ 不得让儿童在无人看管的情况下使用激光测量仪。可能意外地让他人或自己炫目。
- ▶ 请勿在有易燃液体、气体或粉尘的潜在爆炸性环境中使用测量仪。测量仪器内可能产生火花并点燃粉尘和气体。
- ▶ 切勿打开充电电池。可能造成短路。
- ▶ 如果充电电池损坏或者未按照规定使用，充电电池中会散发出有毒蒸汽。充电电池可能会燃烧或爆炸。工作场所必须保持空气流通，如果身体有任何不适必须马上就医。蒸汽会刺激呼吸道。
- ▶ 如果充电电池使用不当或者损坏，可能会有易燃的电解液从充电电池中流出。避免与之接触。如果意外碰到，用水冲洗。如果电解液碰到眼睛，还要寻求医疗帮助。从充电电池流出的液体会刺激或灼伤皮肤。
- ▶ 钉子、螺丝刀等尖锐物品或外力作用可能会损坏充电电池。有可能出现内部短路、蓄电池燃烧、发出烟雾、爆炸或过热。
- ▶ 当电池盒不用时，将它远离其他金属物体，例如回形针、硬币、钥匙、钉子、螺钉或其他小金属物体，以防一端与另一端连接。电池端部短路会引起燃烧或火灾。
- ▶ 只能将此充电电池用在制造商的产品中。这样才能确保充电电池不会过载。
- ▶ 请只用制造商推荐的充电器充电。不可以使用针对某些特定蓄电池的充电器，为其它的蓄电池充电，可能引起火灾。



保护充电电池免受高温（例如长期阳光照射）、火焰、脏污、水和湿气的侵害。有爆炸和短路的危险。



- ▶ 激光视镜（附件）不得用作护目镜。激光视镜用于更好地识别激光束；然而对激光束并没有防护作用。
- ▶ 激光视镜（附件）不得用作太阳镜或在道路交通中使用。激光视镜并不能完全防护紫外线，还会干扰对色彩的感知。

- ▶ 本测量仪装备了一个无线接口。必须注意本地运行限制，例如在飞机上或医院里。

蓝牙®文字标记和图形符号（标志）是Bluetooth SIG公司的注册商标和财产。Robert Bosch Power Tools GmbH根据许可可使用这些文字标记/图形符号。

- ▶ **注意！**在使用配有蓝牙®的测量仪时，其它装置和设备、飞机和医疗器械（例如心脏起搏器、助听器）可能会出现故障。同样不能完全排除周围的人和动物会受到伤害。请不要在医疗设备、加油站、化工厂、有爆炸危险的地区附近和在爆破区内使用配有蓝牙®的测量仪。请不要在飞机上使用配有蓝牙®的测量仪。请避免在身体附近较长时间使用。

## 插头电源安全规章

- ▶ 儿童和身体、感官或精神上有缺陷或缺乏经验与知识的人员不得使用本插头电源。对于八岁以上的儿童和身体、感官或精神上有缺陷或缺乏经验与知识的人员，倘若其得到负责其安全的人员监护或接受过监护人有关插头电源使用的指导并已了解到可能的危险，则可以使用本插头电源。否则会有误操作和人身伤害的危险。

 不得将插头电源暴露在雨中或潮湿环境中。水进入插头电源将增加触电危险。

- ▶ 保持插头电源的清洁。污染会产生触电的危险。
- ▶ 每次使用插入式电源前都要进行检查。一旦发现损坏，请勿使用插入式电源。请勿自行打开插入式电源，只能由 Bosch 或由经授权的客户服务中心用原厂配件进行维修。损坏的插入式电源会提高用户触电的危险。

## 产品和性能说明







### 按照规定使用

本测量仪用于测量距离、长度、高度、间距和倾角以及用于计算面积和体积。

本测量仪器适合在室内使用。  
测量结果可以通过Bluetooth® (蓝牙) 传递给其他设备。

## 图示组件

图示组件的编号和测量仪插图上的一致。

- (1)  蓝牙®键
- (2)  功能键
- (3)  减号键
- (4) 显示屏
- (5)  测量键
- (6)  加号键
- (7)  基本设置键
- (8)  电源开关/返回键
- (9) 挂绳固定座
- (10) 激光警戒牌
- (11) 序列号
- (12) 电池盒盖的固定扳扣
- (13) 电池盒盖
- (14) 1/4英寸三脚架螺纹
- (15) 接收镜头
- (16) 激光束出口
- (17) 挂绳<sup>A)</sup>
- (18) 保护袋

- (19) 锂离子电池组<sup>A)</sup>
- (20) 锂离子电池组的止动件<sup>A)</sup>
- (21) Type-C® USB线<sup>A)B)</sup>
- (22) USB插口盖<sup>A)</sup>
- (23) 皮带扣<sup>A)</sup>
- (24) 皮带扣<sup>A)</sup>螺栓
- (25) 三脚架<sup>A)</sup>
- (26) 激光靶<sup>A)</sup>
- (27) 激光视镜<sup>A)</sup>

A) 图表或说明上提到的附件，并不包含在基本的供货范围中。本公司的附件清单中有完整的附件供应项目。

B) USB Type-C®和USB-C®是USB Implementers Forum的商标。

### 显示元件

- (a) 测量的基准面
- (b) 蓝牙®状态
  - \* 蓝牙®已激活，未建立连接
  - \*• 蓝牙®已激活，已建立连接
- (c) 电池指示灯
- (d) 测量值行
- (e) 测量结果行
- (f) 测量功能显示
- (g) 倾角显示

- (h) 状态栏
- (i) “功能”菜单
- (j) “基本设置”菜单
- (k) “其他基本设置”菜单

## 技术参数

数字式激光测距仪	GLM 50-27 CG
物品代码	<b>3 601 K72 U..</b>
测量范围 <sup>A)</sup>	0.05至50米
测量范围 (不利条件下) <sup>B)</sup>	0.05至20米
测量准确度 <sup>C)</sup>	2级
最小显示单位	0.5毫米
<b>常规</b>	
工作温度 <sup>D)</sup>	-10摄氏度至+45摄氏度
仓储温度	-20摄氏度至+70摄氏度
最大相对湿度	90 %
最高适用海拔	2000米
脏污程度符合 IEC 61010-1	2 <sup>E)</sup>
激光等级	2
激光种类	515纳米, < 1毫瓦
激光束发散角	< 1.5毫弧度 (全角)
自动断开时间约	
- 激光	20秒
- 测量仪 (不测量) <sup>F)</sup>	5分钟
<b>间接距离测量和水准仪</b>	
测量范围	0至360度 (4 × 90度)
<b>倾斜度测量</b>	
测量范围	0至360度 (4 × 90度)

<b>数字式激光测距仪</b>		<b>GLM 50-27 CG</b>
测量精度 <sup>(G)H)</sup>		±0.2度
最小显示单位		0.1度
重量符合EPTA-Procedure 01:2014		0.17公斤
防护类型		IP 65 ( 防尘、防溅 )
尺寸		119 × 53 × 29毫米
尺寸单位设置		米, 英尺, 英寸
电池		2 × 1.5伏特LR6 ( AA )
<b>电池组 ( 附件 )</b>		<b>锂离子</b>
型号		BA 3.7V 1.0Ah A
物品代码		<b>1 607 A35 17H</b>
USB充电接口		Type-C®
额定电压		3.7伏特 ---
电量		1.0安培小时
充电电池单元数量		1
许可的充电温度范围		+10摄氏度至+35摄氏度
<b>插头电源</b>		
输出电压		5.0伏特 ---
最小输出电流		500毫安
<b>数据传输</b>		
蓝牙®		蓝牙® 4.2 低能耗 <sup>1)</sup>
频率范围		2400至2483.5兆赫



## 数字式激光测距仪

GLM 50-27 CG

## 发射功率

≤100毫瓦

- A) 从测量仪的前缘起测量时，适用于目标反射能力强（例如涂刷白色的墙壁）、背景照明暗且工作温度为20摄氏度的情况。
  - B) 从测量仪的前缘起测量时，适用于目标反射能力强（例如涂刷白色的墙壁）、背景照明强且工作温度为20摄氏度的情况。
  - C) JJG 966-2010
  - D) 在持续测量功能中，最大工作温度为+40摄氏度。
  - E) 仅出现非导电性污染，不过有时会因凝结而暂时具备导电性。
  - F) 蓝牙®已禁用
  - G) 在工作温度为25摄氏度时
  - H) 在0度和90度用户校准之后，必须注意±0.01度/度至45度（最大）的螺距误差。测量仪的左侧面用作倾斜度测量的基准面。
  - I) 对于蓝牙® 低功耗设备，视型号和操作系统而定可能不能建立连接。蓝牙® 设备必须支持GATT规范。
- 型号铭牌上的序列号(11)是测量仪唯一的识别码。

## 安装/更换蓄电池

操作测量仪时最好使用碱性锰电池或镍氢电池（尤其当工作温度较低时）。根据容量，使用1.2伏电池可能比使用1.5伏电池的测量次数要多一些。

» 打开蓄电池盒盖。

» 安装好电池或充电电池。

**i** 务必同时更换所有的蓄电池或充电电池。请使用同一制造厂商，容量相同的蓄电池或充电电池。

**i** 根据电池盒内部的图示，注意电极是否正确。

当电池或充电电池电量较低时，显示屏上会显示是否激活省电模式的询问。激活省电模式后，电池使用时间将会延长，显示屏上的电池符号被加上黄色边框。（参见“接通/关闭省电模式”，页 55）

当显示屏上第一次显示空的电池符号时，那么接下来只能再进行几次测量。当电池符号为空且呈红色闪烁时，无法再进行测量。请更换蓄电池或充电电池。

**▶ 长时间不用时，请将蓄电池或充电电池从测量仪中取出。**经过长期搁置，电池会腐蚀或自行放电。

- i** 存放测量仪时，必须始终合上电池盒盖(13)或装上锂离子电池组(19) (附件)，特别是当存放环境多尘或潮湿时。

## 锂离子电池组 (附件)

### 装入/更换锂离子电池组 (附件)

- » 装入锂离子电池组(19) (附件)。
- » 如需取出锂离子电池组(19) (附件)，请按下止动件(20)，然后取出锂离子电池组。(参见插图 A, 页 4)

### 给锂离子电池组 (附件) 充电

- ▶ **充电时请使用推荐的USB电源或输出电压和最小输出电流符合“技术参数”一章中的要求的电源。请注意USB电源的操作说明书。**  
推荐的电源：参见“技术参数”。
- ▶ **注意电源电压！** 电源的电压必须和插头电源上标示的电压数据一致。标记为230伏的插头电源也可用220伏电压运行。
- i** 根据国际运输法规，锂离子电池在交付时已部分充电。首度使用测量仪之前，必须先给电池充足电以确保充电电池的功率。

用于连接USB线(21)的USB插口和充电指示灯位于锂离子电池组(19) (附件)上的USB插口盖(22)下。

- » 打开USB插口盖(22)。
- » 连接USB线(21)。

充电过程中，显示屏上的电池电量显示可能与锂离子电池组(19) (附件)的实际电量有差异。

充电过程中充电指示灯亮起黄色。

当锂离子电池组(19) (附件)完全充满电后，充电指示灯亮起绿色。

如充电电压或充电电流不匹配，充电指示灯会亮起红色。

## 工作

### 投入使用

- ▶ **测量仪接通后应有人看管，使用后应关闭。** 激光可能会让旁人炫目。
- ▶ **不可以让湿气渗入仪器中，也不可以让阳光直接照射在仪器上。**
- ▶ **请勿在极端温度或温度波动较大的情况下使用测量仪。** 比如请勿将测量仪长时间放在汽车内。温度波动较大的情况下，使用测量仪之前先使其温度稳定下来。在极端温度或温度波动较大的情况下，测量仪的精度可能会受到影响。
- ▶ **避免让测量仪发生剧烈碰撞或使其掉落。** 测量仪受到强烈的外部作用之后，在重新使用之前务必进行精度检查(参见“精度检查”，页 70)。

### 接通/关闭

- » 按压按键▲，以接通测量仪和激光。  
 按压按键⊖，您便可以在没有激光的情况下，也能接通测量仪。
- » 按住按键⊖，以关闭测量仪。  
 存储器中的数值和设备设置继续保留。

### 测量过程

第一次开机后，测量仪处于长度测量功能中。以后每次开机后，测量仪都处于上次使用的测量功能中。

测量的基准面有三种设置可用。(参见“选择基准面”，页 52)

- » 将测量仪放到需要的开始点（如墙壁）上。
- » 当通过按钮⊖启动测量仪后，短按按键▲以接通激光。
- » 按压按键▲，以触发测量。

在测量过程后，激光束将关闭。如要进行下一次测量，请重复这个过程。

测量值或最终结果可以进行加或减操作。

测量值通常在0.5秒内、最晚在约4秒后出现。

测量时长取决于距离、照明条件和目标面的反射特性。在测量过程后，激光束将自动关闭。

 测量期间不允许移动测量仪（持续测量及倾斜度测量功能除外）。因此将测量仪尽可能放在固定的止档面或支撑面上。

 测量时，不得遮挡接收镜头(15)和激光束出口(16)。

### 影响测量范围的因素

测量范围取决于照明条件和目标面的反射特性。

外来光线过强时，为了更好地看清激光束，可使用激光束护目镜(27)（附件）和激光目标靶(26)（附件），或遮暗目标面。

### 影响测量结果的因素



基于物理原理，无法避免在不同的表面上进行测量时产生的误差。其中包括：

- 透明表面（例如玻璃、水），
- 反光表面（例如抛光金属、玻璃），
- 多孔表面（例如绝缘材料），
- 有纹路的表面（例如粗糙的灰泥墙、天然石）。

必要时，在这些表面上使用激光靶(26)（附件）。

另外，如果对目标面进行斜线瞄准，也可能产生误测。此外有温差的空气层和间接的反射都可能影响测量值。

### 菜单中的导航

在菜单中，可以通过按键向右，和通过按键向左切换。

如要确认选择，请按压按键或按键。

如要退出菜单，请按压按键。

### 选择基准面

测量时可以选择不同的基准面：



测量仪的后缘（例如贴靠在墙上时）



三脚架螺纹(14)的中部（例如在用三脚架测量时）



测量仪的前缘（例如在从台面棱边开始测量时）

» 按压按键以打开**基本设置**菜单。

» 选择。

» 通过按键或选择所需的基准面。











» 按压按键, 以确认选择。

每次接通测量仪后都被预设为上次选择的基准面。

无法在完成测量后再对基准面进行事后更改（例如在测量值已显示在测量值列表中时）。



## “基本设置”菜单

在**基本设置**菜单中，可找到以下基本设置：

-  切换基准面(参见“选择基准面”，页 52)
-  接通/关闭声音信号
-  接通/关闭振动
-  设置显示屏亮度
-  接通/关闭省电模式
-  切换尺寸单位
-  设置语言
-  倾斜度测量校准(参见“精度检查”，页 70)
-  调出设备信息
-  出厂设置
-  删除存储器内容

» 按压按键以打开**基本设置**菜单。









» 通过按键或按键选择所需的设置。

» 如要确认选择，请按压按键或按键。

- » 短按按键  以关闭**基本设置**菜单。

### 接通/关闭声音信号

在基本设置中声音是打开的。

- » 按压按键  以调用**基本设置**  菜单。
- » 选择 。
- » 如要更改选择，请按压按键  或按键 。
- » 按压按键  或按键 ，以确认选择。
- » 短按按键  以关闭**基本设置**  菜单。  
测量仪关闭后，选择的设置继续保存。

### 接通/关闭振动





在基本设置中振动是打开的。

测量仪的振动在诸如嘈杂环境中是一项非常有用的辅助功能。两次短促的振动代表已成功进行测量；一次长振动代表测量有错误。

- » 按压按键  以调用**基本设置**  菜单。
- » 选择 。
- » 如要更改选择，请按压按键  或按键 。
- » 按压按键  或按键 ，以确认选择。
- » 短按按键  以关闭**基本设置**  菜单。  
测量仪关闭后，选择的设置继续保存。

### 设置显示屏亮度

显示屏的亮度可分成数个等级根据环境条件进行调整。

- » 按压按键  以调用**基本设置**  菜单。
- » 选择 。
- » 如要更改选择，请按压按键  或按键 。

- » 按压按键▲或按键Func，以确认选择。
- » 短按按键Ⓞ以关闭基本设置⚙️菜单。  
测量仪关闭后，选择的设置继续保存。

### 接通/关闭省电模式🔌

在基本设置中省电模式是关闭的。当接通省电模式后，声音和振动将被关闭，显示屏亮度被降低。这样可以延长电池的使用时间。

- » 按压按键⚙️以调用基本设置⚙️菜单。
- » 选择🔌。
- » 如要更改选择，请按压按键▶️或按键◀️。
- » 按压按键▲或按键Func，以确认选择。
- » 短按按键Ⓞ以关闭基本设置⚙️菜单。  
测量仪关闭后，选择的设置继续保存。











### 切换尺寸单位📏

基本设置为尺寸单位“m”（米）。提供了六种不同的尺寸单位。请根据您的用途设置到合适的尺寸单位。

- » 按压按键⚙️以调用基本设置⚙️菜单。
- » 选择📏。
- » 如要更改选择，请按压按键▶️或按键◀️。
- » 按压按键▲或按键Func，以确认选择。
- » 短按按键Ⓞ以关闭基本设置⚙️菜单 Ⓞ  
测量仪关闭后，选择的设置继续保存。







### 设置语言🗨️

第一次接通测量仪时，系统会要求您对显示屏上显示的文字语言进行设置。您可以随时更改设定的语言。

- » 按压按键  以调用 **基本设置**  菜单。
- » 选择  以进行其他设置。
- » 选择 。
- » 如要更改选择，请按压按键  或按键 。
- » 按压按键  或按键 ，以确认选择。
- » 短按按键  以关闭 **基本设置**  菜单。  
测量仪关闭后，选择的设置继续保存。









### 设备信息

此处可以找到与测量仪相关的信息，例如序列号、软件版本和许可证。

- » 按压按键  以调用 **基本设置**  菜单。
- » 选择  以进行其他设置。
- » 选择 。
- » 短按按键  以关闭 **基本设置**  菜单。

### 出厂设置







该功能用于将测量仪恢复到出厂设置/基本设置。复位后，系统会要求对显示屏上显示的文字语言进行设置。

- » 按压按键  以调用 **基本设置**  菜单。
- » 选择  以进行其他设置。
- » 选择 。
- » 如需重置测量仪，请选择  并通过按键  或  进行确认。
- » 短按按键  以关闭 **基本设置**  菜单。

### 删除存储器内容

- » 按压按键  以调用 **基本设置**  菜单。



















- » 选择  以进行其他设置。
- » 选择 。
- » 如需删除存储器内容，请通过按键  或  选择 ，然后通过按键  或  进行确认。  
将删除所有测量值。

## 测量功能

### 选择/更改测量功能

在功能菜单中，可找到以下功能：

-  长度测量
-  持续测量
-  面积测量
-  体积测量
-  间接距离测量
  -  间接高度测量
  -  双重间接高度测量
  -  间接长度测量
-  墙壁面积测量
-  放样功能
-  倾斜度测量/数字式水平仪
-  储存功能



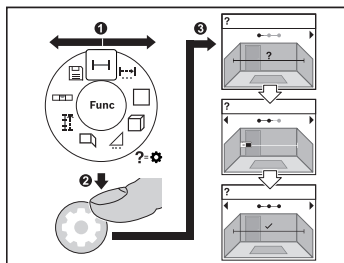

- » 按压按键 ，以打开**功能菜单**。
- » 通过按键  或按键  选择所需的测量功能。
- » 按压按键  或按键 ，以确认选择。

## 集成的辅助功能 ?







或上一步。

集成在测量仪中的辅助功能可对所有测量功能/测量过程提供动画短片。

- » 打开**功能**菜单。
- » 通过按键  或通过按键  选择所需的功能，然后按压按键 。
- 显示所选测量功能的含详细操作步骤的动画短片。
- » 按压按键  或 ，以显示下一步

## 长度测量

- » 按压按键 ，以打开**功能**菜单。
- » 选择长度测量 ，并通过按键  确认选择。
- » 短促按压按键 ，以接通激光。
- » 按压按键 ，以触发测量。

测量值在显示屏下方的结果行(e)中显示。



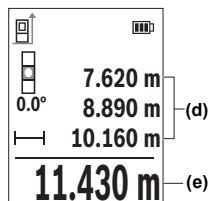

- » 如要进行下一次测量，请重复上述步骤。



如果先后进行了多次长度测量，便会在测量值行(d)中显示最近几次测量的结果。最后一个测量值显示在显示屏下方，倒数第二个测量值显示在其上方，然后依次类推。

## 面积测量

- » 按压按键 ，以打开**功能**菜单。

- » 选择面积测量 ，并通过按键  确认选择。
- » 短促按压按键 ，以接通激光。
- » 按压按键 ，以触发首次测量，例如一个房间的长度。
- » 按压按键 ，以触发第二次测量，例如一个房间的宽度。

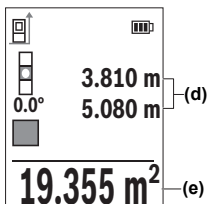

两次测量结束后会自动计算和显示面积。结果在结果行(e)中显示。各个测量值位于测量值行(d)中。

### 持续测量





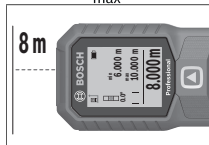

在持续测量时，测量值会不断更新。例如，您可以从一堵墙出发，移动所需的距离，这样将随时可以读取当前的距离。

有三个功能可用于持续测量，显示屏中会分别显示不同的测量内容：

### 最小/最大



在显示屏上持续显示最小或最大的测量值（参见插图）。

- » 按压按键 ，以打开功能菜单。
- » 选择持续测量菜单项  中的最小/最大  $\min_{\max}$ ，并通过按键  确认选择。
- » 短促按压按键 ，以接通激光。
- » 移动测量仪，直至所需的距离显示在结果行中。  
您可以短促按压按键 ，以中断持续测量。
- » 再次按压按键 ，以继续持续测量。

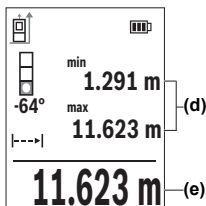

当前测量值显示在结果行(e)中，最大和最小的测量值显示在测量值行(d)中。

### 大数字00<sup>+</sup>

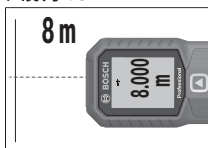

放大显示测量值，以便于看清。

### 测量卷尺

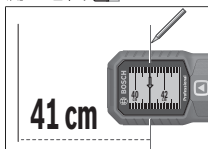





像测量卷尺那样显示距离。

**i** 在测量卷尺功能中，基准面就是显示屏上所显示的标记。基准面不是测量仪的边缘。

持续测量在4分钟后自动关闭。

### 体积测量

- » 按压按键 ，以打开**功能菜单**。
- » 选择体积测量 ，并通过按键  确认选择。
- » 短促按压按键 ，以接通激光。
- » 按压按键 ，以触发首次测量，例如一个房间的长度。

» 按压按键▲，以触发第二次测量，例如一个房间的宽度。

» 按压按键▲，以触发第三次测量，例如一个房间的高度。

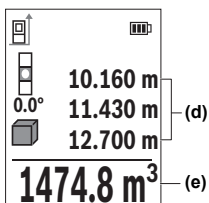

三次测量结束后会自动计算和显示体积。结果在结果行(e)中显示。各个测量值位于测量值行(d)中。

### 间接距离测量



间接距离测量用于确定无法直接测量的距离，例如有障碍物阻挡了光路或者没有目标面可以充当反射体时。该测量方法只适用于垂直方向。任何水平方向的偏差都会导致测量错误。

间接距离测量始终不及直接距离测量精确。由使用情况决定，测量误差可能比直接距离测量时大。为了提高测量精度，我们建议使用三脚架（附件）。

 使用三脚架时，请注意所设置的基准面。（参见“选择基准面”，页 52）

在各个单一测量之间激光保持接通。



间接距离测量有3种测量功能可用，通过这些相应的功能可以确定不同的线段。

-  间接高度测量
-  双重间接高度测量
-  间接长度测量

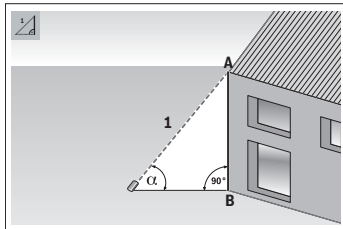
### 间接高度测量



通过间接高度测量，可以通过测量线段1，以确定线段AB。测量仪从角度 $\alpha$ 和线段1计算出所求的高度AB。在激光和待测量的线段的夹角成直角时，才能够测量出正确的结果。

- » 按压按键 **Func**，以打开**功能菜单**。
- » 选择间接距离测量 ，并通过按键 **Func** 确认选择。
- » 选择间接高度测量 ，并通过按键 **Func** 确认选择。
- » 短促按压按键 **▲**，以接通激光。
- » 将测量仪置于下部测量点B的高度。
- » 将测量仪倾斜，令激光对准上部测量点A。
- » 按压按键 **▲**，以触发测量。

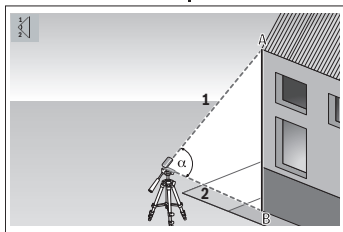

测量结束后会自动计算高度，并显示在结果行(e)中。线段1和角度 $\alpha$ 的测量值位于测量值行(d)中。

### 双重间接高度测量





通过双重间接高度测量，可以通过测量线段1和2，以确定线段AB。测量仪从角度 $\alpha$ 和线段1和2计算出所求的高度AB。

进行该测量时，建议使用三脚架。

- » 按压按键 **Func**，以打开**功能菜单**。
- » 选择间接距离测量 ，并通过按键 **Func** 确认选择。
- » 选择双重间接高度测量 ，并通过按键 **Func** 确认选择。
- » 短促按压按键 **▲**，以接通激光。
- » 将测量仪倾斜，令激光对准上部测量点 **A**。
- » 按压按键 **▲**，以触发首次测量。
- » 将测量仪倾斜，令激光对准下部测量点 **B**。同时不得更改测量仪的位置。
- » 按压按键 **▲**，以触发第二次测量。

测量结束后会自动计算高度，并显示在结果行 **(e)** 中。线段 **1**、**2** 和角度  $\alpha$  的测量值位于测量值行 **(d)** 中。

### 间接长度测量

- » 按压按键 **Func**，以打开**功能菜单**。
- » 选择间接距离测量 ，并通过按键 **Func** 确认选择。
- » 选择间接长度测量 ，并通过按键 **Func** 确认选择。
- » 将测量仪置于所求线段 **AB** 的起点 **A** 上。
- » 将测量仪倾斜，令激光对准终点 **B** 所在的平面。
- » 按压按键 **▲**，以触发测量。

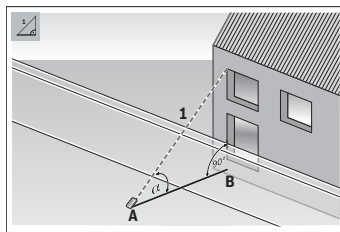

通过间接长度测量，可以通过测量线段 **1**，以确定线段 **AB**。测量仪从角度  $\alpha$  和线段 **1** 计算出所求的长度 **AB**。

测量结束后会自动计算长度，并显示在结果行(e)中。线段1和角度 $\alpha$ 的测量值位于测量值行(d)中。

### 墙壁面积测量

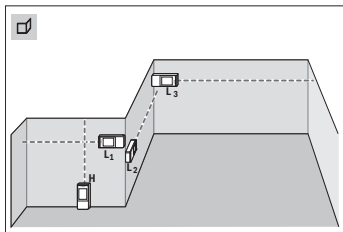

墙壁面积测量是用来计算高度相同的数个单一墙面的总面积。正确面积计算的前提条件是，第一个测得的长度（在本例中是空间高度H）对于所有子面积都相同。在图示的例子中要测定空间高度H相同但长度L不同的多个墙面的总面积。

- » 按压按键 $\text{Func}$ ，以打开**功能菜单**。
- » 选择墙壁面积测量，并通过按键 $\text{Func}$ 确认选择。
- » 请与长度测量时一样测量空间高度H。  
测量值在上部的测量值行中显示。激光保持接通状态。
- » 然后测量第一堵墙的长度L1。  
面积自动计算出来并在结果行中显示。最后一个长度测量值位于下部的测量值行中。激光保持接通状态。
- » 现在测量第二堵墙的长度L2。

您可以测量任意多个其它长度LX，它们将自动相加，然后乘以高度H。

测量值行(d)中显示的各个测量值被加到长度L1上。两个长度的总和（显示在中部的测量值行(d)中）被乘以存储的高度H。总面积值在显示屏下方的结果行(e)中显示。

### 放样功能

- ① 在放样功能中，基准面就是显示屏上所显示的标记。基准面不是测量仪的边缘。



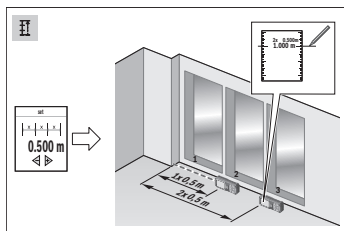

放样功能重复测量某个定义的长度（线段）。这些长度可以传递到某个表面上，例如能够将材料剪切成相同长度的工件或建立干墙式墙架结构。可调节的最小长度为0.1米，最大长度为50米。

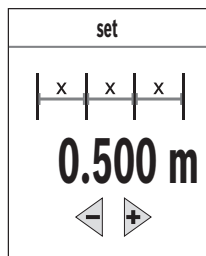

» 按压按键 **Func**，以打开**功能菜单**。

» 选择放样功能 **III**，并通过按键 **Func** 确认选择。

» 通过按键 **▶** 或按键 **◀** 设置所需的长度。

按住按键 **▶** 或按键 **◀**，可以较大的步距更改长度。

» 按压按键 **▲**，以启动放样功能，然后缓慢地从起点离开。

测量仪连续测量到起点的间距。同时显示定义的长度以及当前的测量值。下部或上部箭头指示到下一个或上一个标记的最小距离。



左侧的系数表明，定义的长度已经达到多少次。显示屏上侧面的绿色线条指示达到一个用于标记的长度。

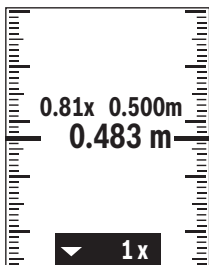

如果参考值超出显示屏，则蓝色线条和蓝色字样指示实际值。

### 倾斜度测量/数字式水平仪

数字式水平仪用于检测一个目标（例如洗衣机、冰箱等）的水平或垂直定位。倾斜度测量用于测量（例如楼梯、栏杆，以及装配家具时或敷设管道时等）的斜度或倾角。当更改测量仪的位置时，测量仪便会自动在两项功能之间切换。

» 按压按键 ，以打开**功能菜单**。

» 选择倾斜度测量/数字式水平仪 ，并通过按键  确认选择。

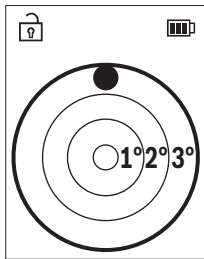

测量仪的底面用作数字式水平仪的基准面。

» 如要使用数字式水平仪，请将测量仪的背面置于所要测量的表面上。

您可以按压按键 ，以固定测量值。

» 如果倾角超过3度，则显示屏中的球呈红色亮起。

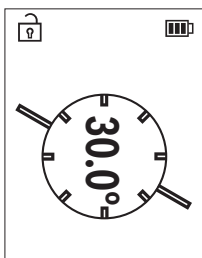

测量仪的左侧面用作倾斜度测量的基准面。测量过程中如果显示开始闪烁，说明测量仪过度侧向侧倾。

» 如要使用倾斜度测量，请将测量仪的侧面置于要测量其倾斜度的对象上。

您可以按压按键▲，以固定测量值。

## 储存功能

每个结束的测量的数值或最终结果都会自动存储。保存最近的30个数值（测量值或最终结果）。如果存储器已满，便会覆盖最早的值。最早的数值位于存储器中的位置1上，最新的数值位于位置30上（有30个可用的保存值时）。

» 按压按键func，以打开功能菜单。

» 选择储存功能，并通过按键func确认选择。



显示最后一个数值。

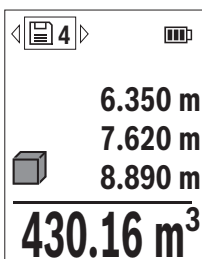

» 按压按键▶或按键◀，可以翻阅所保存的数值。



显示屏上部显示保存值的编号，左侧显示相应测量功能的图标。如果存储器中没有数值可用，则显示屏下部显示“0.000”而上部显示“0”。

## 删除保存值

- » 如要删除所显示的数值，请按压按键 。
- » 通过按键  确认。

如要删除所保存的所有数值，请在**基本设置**菜单  中选择菜单项**删除存储器**。(参见“删除存储器内容 ”，页 56)

## 加/减数值

### 长度测量时加数值

- » 选择长度测量功能。
- » 进行首次测量。
- » 按压按键 。
- » 进行第二次测量。

一旦第二次测量结束，第二次测量的结果便会显示在测量值行(d)中，最终结果显示在结果行(e)中。

### 面积和体积测量时加数值

- » 选择面积测量或体积测量功能。
- » 进行首次面积测量或体积测量。
- » 按压按键 。
- » 进行第二次面积测量或体积测量。

一旦第二次或第三次测量结束，便会自动计算并显示面积或体积。结果在结果行(e)中显示。各个测量值位于测量值行(d)中。

- » 按压按键 ，以显示相加的最终结果。

最终结果在结果行(e)中显示。各次面积或体积测量的结果位于测量值行(d)中。

## 减数值

» 如要减数值，请按压按键 。后续操作类似于“加数值”。

## 删除测量值

您可以通过短促按压按键 ，在所有测量功能中删除最后确定的测量值。

多次短促按压按键 ，可按倒序删除测量值。

## 蓝牙®接口

### 与其它设备之间的数据传输

测量仪装备了蓝牙®模块，通过蓝牙®接口将数据无线传输给特定的移动终端设备（比如智能手机、平板电脑）。

关于建立蓝牙®连接所需的系统前提条件的信息，可在博世网站上找到：  
[www.bosch-pt.com](http://www.bosch-pt.com)。

► 更多信息请查阅博世产品页。

在通过蓝牙®进行数据传输时，在移动终端设备与测量仪之间可能出现时间延迟。原因可能在于两个设备之间的距离或测量物体本身。

### 激活蓝牙®接口以便将数据传输到一个移动终端设备上

✓ 请确保移动终端设备上的蓝牙®接口已激活。

» 按压按键  以调用蓝牙®菜单。

» 再次按压按键  以激活蓝牙®接口。

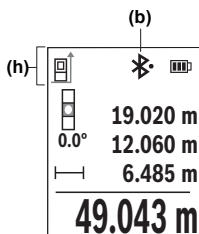

在测量仪的状态栏(h)中显示连接状态和激活的连接

(b)。

提供的博世应用程序可扩展功能范围。这些应用程序可以根据终端设备在相应的应用商店中下载。

在启动博世应用程序后，会在移动终端设备和测量仪之间建立连接。如果找到多个激活的测量仪，请根据序列号选择合适的测量仪。序列号(11)在测量仪的型号铭牌上。

## 停用蓝牙®接口

» 按压按键  以调用蓝牙®菜单，然后再次按压按键  以关闭蓝牙®接口。

## 精度检查

定期检查倾斜度测量和距离测量的精度。

### 倾斜度测量的精度检查和校准

» 为此将测量仪置于一个桌面上并测量倾斜度。

» 将测量仪旋转180度，然后再次测量倾斜度。

显示值之差最大允许为0.3度。

如果有更大的偏差，必须重新校准测量仪。

» 按压按键  以打开基本设置菜单。

» 选择 ，并通过按键  确认选择。

» 请遵照显示屏上的指示操作。

 在温度剧烈变化后和在发生碰撞后，我们建议进行精度检查，并在必要时校准测量仪。发生温度变化后，在校准前必须等待一些时间，让测量仪温度稳定下来。

### 距离测量精度检查

进行精度检查时，测量应在条件良好的情况下进行，即测量距离应在背景照度弱的室内且测量目标面应光滑且反射效果好（例如涂刷白色的墙壁）。

» 选择一个您确切知道的测量距离，大约3至10米（例如房间宽度、门洞）。

» 连续测量距离10次。

在条件良好情况下，整个测量距离上的单次测量值与确切知道的尺寸的误差最大为±2毫米。记录测量情况，以便以后能对精度进行比较。

## 使用三脚架（附件）工作

如果距离较远，使用三脚架尤为有益。

- » 将测量仪用1/4英寸螺纹(14)安装到三脚架(25)或市售摄影三脚架的快拆板上。
- » 用快拆板的固定螺丝拧紧测量仪。
- » 利用三脚架调整测量基准面(参见“选择基准面”, 页 52)。

## 皮带扣

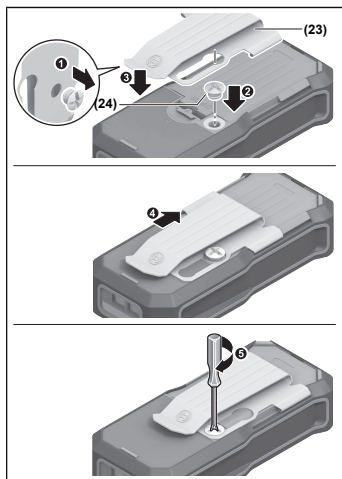

利用皮带扣(23)可以方便地将测量仪挂在皮带上。  
如需将皮带扣安装到测量仪上, 请按照插图中的步骤操作。

## 故障信息

如果测量无法正确进行, 则显示屏上会显示故障信息**Error**。

- » 请重新尝试执行测量过程。
- » 如果再次出现故障信息, 请关闭测量仪再重新接通, 然后再次启动测量。



每次测量时, 测量仪都会监控功能是否正常。如果发现故障, 则显示屏只显示旁边的图标, 并且测量仪会自动关闭。在这种情况下请将测量仪通过经销商交给博世客户服务部。

## 维修和服务

### 维护和清洁

使用附带的保护套储存和携带仪器。

测量仪器必须随时保持清洁。

不可以把仪器放入水或其它的液体中。

使用潮湿、柔软的布擦除仪器上的污垢。切勿使用任何清洁剂或溶剂。

请像对待眼镜或照相机镜头那样特别小心地保养接收镜头(15)。

需要修理时，请将测量仪装入保护袋(18)邮寄。

### 客户服务和应用咨询

本公司顾客服务处负责回答有关本公司产品的修理、维护和备件的问题。备

件的展开图纸和信息也可查看：[www.bosch-pt.com](http://www.bosch-pt.com)

博世应用咨询团队乐于就我们的产品及其附件问题提供帮助。

询问和订购备件时，务必提供机器铭牌上标示的10位数物品代码。

#### 中国大陆

博世电动工具（中国）有限公司

中国 浙江省 杭州市

滨江区 滨康路567号

102/1F 服务中心

邮政编码：310052

电话：(0571)8887 5566 / 5588

传真：(0571)8887 6688 x 5566# / 5588#

电邮：[bsc.hz@cn.bosch.com](mailto:bsc.hz@cn.bosch.com)

[www.bosch-pt.com.cn](http://www.bosch-pt.com.cn)

#### 制造商地址：

Robert Bosch Power Tools GmbH

罗伯特·博世电动工具有限公司

70538 Stuttgart / GERMANY

70538 斯图加特 / 德国

#### 其他服务地址请见：

[www.bosch-pt.com/serviceaddresses](http://www.bosch-pt.com/serviceaddresses)



## 搬运

所推荐的锂离子充电电池必须符合危险物品法规。使用者无须另外使用保护包装便可以运送该充电电池。

但是如果将它交由第三者运送（例如：寄空运或委托运输公司）则要使用特殊的包装和标示。此时必须向危险物品专家请教有关寄送危险物品的相关事宜。

确定充电电池的外壳未受损后，才可以寄送充电电池。粘好未加盖的触点并包装好充电电池，不可以让充电电池在包装中晃动。必要时也得注意各国有关的法规。

## 处理废弃物



应对测量仪、蓄电池/电池、附件和包装进行环保的回收利用。



请勿将测量仪和电池/蓄电池扔到生活垃圾里。

**蓄电池/电池：**

**锂离子：**

请注意 搬运 段落中的指示。（参见“搬运”，页 73）。

## 附件

您可以通过给出的链接，在博世网站上找到附件



BA 3.7V 1.0Ah A (19)

1 608 M00 C5D

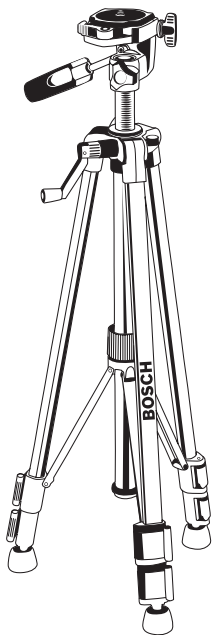

三脚架BT 150 (25)

0 601 096 B00

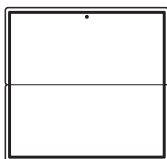

激光靶(26)

2 607 001 391



激光视镜 (绿色) (27)

1 608 M00 05J

### 产品中有害物质的名称及含量

部件名称	有害物质					
	铅 (Pb)	汞 (Hg)	镉 (Cd)	六价铬 (Cr <sup>+6</sup> )	多溴联苯 (PBB)	多溴联苯醚 (PBDE)
外壳的金属部分	○	○	○	○	○	○
外壳的非金属部分 (包括玻璃)	○	○	○	○	○	○
显示器	○	○	○	○	○	○
键盘	○	○	○	○	○	○
内部连接电缆	○	○	○	○	○	○
振动马达 <sup>A)</sup>	○	○	○	○	○	○
组合印刷电路板	X	○	○	○	○	○
绿色激光二极管	X	○	○	○	○	○
附件 <sup>B)</sup>	○	○	○	○	○	○
碱性锰电池系统	X	○	○	○	○	○

A) 适用于采用振动马达的产品

B) 适用于采用附件的产品

本表是按照SJ/T 11364的规定编制

○：表示该有害物质在该部件所有物质材料中的含量均在GB/T 26572规定的限量要求以下。

X：表示该有害物质至少在该部件的某一物质材料中的含量超出GB/T 26572规定的限量要求，且目前业界没有成熟的替代方案，符合欧盟RoHS指令环保要求。

产品环保使用期限内的使用条件参见产品说明书。

## 繁體中文

### 安全注意事項



為確保能夠安全地使用本測量工具，您必須完整詳讀本說明書並確實遵照其內容。若未依照現有之說明內容使用測量工具，測量工具內部所設置的防護措施可能無法發揮應有功效。謹慎對待測量工具上的警告標示，絕對不可讓它模糊不清而無法辨識。請妥善保存說明書，將測量工具轉交給他人時應一併附上本說明書。

- ▶ **小心** - 若是使用非此處指明的操作設備或校正設備，或是未遵照說明的操作方式，可能使您暴露於危險的雷射光照射環境之下。
- ▶ 本測量工具出貨時皆有附掛雷射警示牌（即測量工具詳解圖中的標示處）。
- ▶ 雷射警示牌上的內容若不是以貴國語言書寫，則請於第一次使用前將隨附的當地語言說明貼紙貼覆於其上。



請勿將雷射光束對準人員或動物，您本人亦不可直視雷射光束或使雷射光束反射。因為這樣做可能會對他人眼睛產生眩光，進而引發意外事故或使眼睛受到傷害。

- ▶ 萬一雷射光不小心掃向眼睛，應立刻閉上眼睛並立刻將頭轉離光束範圍。
- ▶ 請勿對本雷射裝備進行任何改造。
- ▶ 本測量工具僅可交由合格的專業技師以原廠替換零件進行維修。如此才能夠確保本測量工具的安全性。
- ▶ 不可放任兒童在無人監督之下使用本雷射測量工具。他們可能會不小心對他人或自己的眼睛造成眩光。
- ▶ 請不要在存有易燃液體、氣體或粉塵等易爆環境下操作本測量工具。測量工具內部產生的火花會點燃粉塵或氣體。

- ▶ 切勿拆開充電電池。可能造成短路。
- ▶ 如果充電電池損壞了，或者未按照規定使用充電電池，充電電池中會散發出有毒蒸氣。充電電池可能起火或爆炸。工作場所必須保持空氣流通，如果身體有任何不適必須馬上就醫。充電電池散發的蒸氣會刺激呼吸道。
- ▶ 不當使用或充電電池受損時，充電電池可能會流出可燃液體。請避免接觸。意外沾到時，請用水徹底沖洗。如果液體跑進眼睛裡，請進一步就醫。從電池中滲出的液體可能造成腐蝕或起火。
- ▶ 尖銳物品（例如釘子或螺絲起子）或是外力皆有可能造成充電電池損壞。進而導致內部短路而發生電池起火、冒煙、爆炸或過熱等事故。
- ▶ 充電電池不使用時，請讓它遠離迴紋針、硬幣、鑰匙、釘子、螺釘或其他小金屬物體，以免造成兩極相接。電池端點短路會引起燃燒或火災。
- ▶ 僅可使用產品的原廠充電電池。如此才可依照產品提供過載保護。
- ▶ 僅能使用製造商規定的充電器進行充電。將適用於某特定電池盒的充電器用於其他電池盒時，可能會造成起火燃燒。



保護充電電池免受高溫（例如長期日照）、火焰、污垢、水液和濕氣的侵害。有爆炸及短路之虞。



- ▶ 請勿將雷射眼鏡當作護目鏡（配件）使用。雷射眼鏡是用來讓您看清楚雷射光束；但它對於雷射光照射並沒有保護作用。
- ▶ 請勿將雷射眼鏡當作護目鏡（配件）使用，或在道路上行進間使用。雷射眼鏡無法完全阻隔紫外線，而且還會降低您對於色差的感知能力。
- ▶ 本測量工具配備無線介面。請您務必遵守不同場所的使用限制條件，例如在飛機或醫院內。

藍牙® 一詞及其標誌（商標）為 Bluetooth SIG, Inc. 所擁有之註冊商標。Robert Bosch Power Tools GmbH 對於此詞彙 / 標誌之任何使用均已取得授權。

- ▶ 小心！使用測量工具時若開啟 藍牙®（藍牙）功能，將可能對其他裝置或設備、飛機以及醫療器材（例如心律調節器、助聽器等）產生干擾。同樣

亦無法完全排除對鄰近之人員或動物造成身體危害的可能性。請勿在醫療器材、加油站、化學設備、爆炸危險場所以及易爆環境等處附近，使用測量工具的 **藍牙®** 功能。請勿在飛機上使用測量工具的 **藍牙®** 功能。應避免直接貼靠在身體部位旁長時間持續操作。

## 電源變壓器的安全注意事項

- ▶ 本電源變壓器不適合兒童以及身體、感官或心智能力有缺陷，或是缺乏相關經驗及知識的人士使用。8 歲以上兒童以及身體、感官或心智能力有缺陷，或是缺乏相關經驗及知識的人士，只要在他人監督下或接受過如何安全處置此電源變壓器的指導，並充份瞭解相關危險，即可使用該電源變壓器。否則可能會造成操作上的錯誤，進而使人員受傷。



不得將電源變壓器暴露在雨中或潮濕環境中。如有水滲入電源變壓器內，將增加觸電風險。

- ▶ 電源變壓器請保持乾淨。髒污亦有造成人員觸電之虞。
- ▶ 每次使用前，請仔細檢查電源變壓器。若有發現任何受損現象，請勿使用電源變壓器。請勿自行拆開電源變壓器並將其交由 Bosch 或授權的客戶服務中心以原廠替換零件進行維修。損壞的電源變壓器將增加觸電風險。

## 產品和規格

### 依規定使用機器







該測量工具是用來測量距離、長度、高度、間距、傾角，並具有計算面積及體積之功能。

本測量工具適合在室內使用。

測量結果可透過 **藍牙®**功能傳送至其他裝置。

### 插圖上的機件

機件的編號和儀器圖示上的編號一致。

- (1)  藍牙<sup>®</sup> 按鈕
- (2)  功能按鈕
- (3)  減號按鈕
- (4) 顯示器
- (5)  測量按鈕
- (6)  加號按鈕
- (7)  基本設定按鈕
- (8)  電源 / 返回按鈕
- (9) 腕帶繫座
- (10) 雷射警示牌
- (11) 序號
- (12) 電池盒蓋鎖扣
- (13) 電池盒蓋
- (14) 供三腳架使用的 1/4" 螺紋孔
- (15) 接收點
- (16) 雷射光束出口
- (17) 腕帶<sup>A)</sup>
- (18) 保護套袋
- (19) 鋰離子充電電池組<sup>A)</sup>
- (20) 鋰離子充電電池組鎖扣<sup>A)</sup>
- (21) USB Type-C<sup>®</sup> 傳輸線<sup>A)B)</sup>

- (22) USB 插孔護蓋<sup>A)</sup>
- (23) 腰帶夾<sup>A)</sup>
- (24) 腰帶夾螺絲<sup>A)</sup>
- (25) 三腳架<sup>A)</sup>
- (26) 雷射標靶<sup>A)</sup>
- (27) 雷射辨識鏡<sup>A)</sup>

A) 圖文中提到的配件，並不包含在基本的供貨範圍中。本公司的配件清單中有完整的配件供應項目。

B) USB Type-C® 和 USB-C® 商標為 USB Implementers Forum 所有。

#### 指示元件

- (a) 測量基準點
- (b) 藍牙® 狀態
  - ✦ 藍牙® 功能已啟用，未建立連線
  - ✦ 藍牙® 功能已啟用，已成功連線
- (c) 電池電量指示器
- (d) 測量值顯示列
- (e) 測量結果顯示列
- (f) 測量功能指示器
- (g) 傾角指示器
- (h) 狀態列
- (i) 功能選單
- (j) 基本設定選單



## (k) 進階基本設定選單

## 技術性數據

數位雷射測距儀	GLM 50-27 CG
產品機號	<b>3 601 K72 U..</b>
測量範圍 <sup>A)</sup>	0.05–50 m
測量範圍 (在不利條件下) <sup>B)</sup>	0.05–20 m
測量準確度 <sup>A)</sup>	±1.5 mm
測量準確度 (在不利條件下) <sup>B)</sup>	±3.0 mm
最小顯示單位	0.5 mm
<b>一般資訊</b>	
操作溫度 <sup>C)</sup>	-10 °C ... +45 °C
儲藏溫度	-20 °C ... +70 °C
空氣相對濕度最大值	90 %
最高適用海拔	2000 m
依照 IEC 61010-1, 污染等級為	2 <sup>D)</sup>
雷射等級	2
雷射種類	515 nm, < 1 mW
雷射光束發散角	< 1.5 mrad (全角度)
自動關機的執行時間點, 約略值	
- 雷射	20 秒
- 測量工具 (未進行測量) <sup>E)</sup>	5 分
<b>間接距離測量和水平儀</b>	
測量範圍	0°–360° (4 × 90°)
<b>傾角測量</b>	
測量範圍	0°–360° (4 × 90°)
測量準確度 <sup>F)G)</sup>	±0.2°
最小顯示單位	0.1°
重量符合 EPTA-Procedure 01:2014	0.17 kg

## 82 | 繁體中文

數位雷射測距儀	GLM 50-27 CG
防護等級	IP 65 ( 防塵防潑濺 )
尺寸	119 × 53 × 29 mm
設定計量單位	m , ft , in
電池	2 × 1.5 V LRR6 (AA)
<b>充電電池組 ( 配件 )</b>	<b>鋰離子</b>
類型	BA 3.7V 1.0Ah A
產品機號	<b>1 607 A35 17H</b>
USB 充電口	Type-C®
額定電壓	3.7 V ---
容量	1.0 Ah
充電電池數量	1
容許的充電溫度範圍	+10°C ... +35°C
<b>電源變壓器</b>	
輸出電壓	5.0 V ---
最低輸出電流	500 mA
<b>資料傳輸</b>	
藍牙®	藍牙® 4.2 (Low Energy) <sup>(H)</sup>
工作頻率範圍	2402–2480 MHz

## 數位雷射測距儀

GLM 50-27 CG

最大發射功率

8 mW

- A) 以測量工具前緣為測量起點，在目標物反射率高（例如白漆牆）、背景照明微弱、操作溫度為 20 °C 時；應額外再依距離將  $\pm 0.05$  mm/m 誤差列入計算。
- B) 以測量工具前緣為測量起點，在目標物反射率高（例如白漆牆）、背景照明強烈、操作溫度為 20 °C 和位於高海拔位置時；應額外再依距離將  $\pm 0.15$  mm/m 的誤差列入計算。
- C) 使用連續測量功能時的操作溫度最高為 +40 °C。
- D) 只產生非傳導性污染，但應預期偶爾因水氣凝結而導致暫時性導電。
- E) 藍牙® 為停用狀態
- F) 在操作溫度 25 °C 下
- G) 使用者在進行 0° 與 90° 校正後，45°（最大值）以下必須另外加上每度  $\pm 0.01^\circ$  的螺旋誤差。測量工具的左側為傾角測量的基準點。
- H) 具有 Bluetooth® 低功耗功能之工具裝置，視其機型和作業系統，可能會有無法建立連線之情形。Bluetooth® 裝置必須支援 GATT 模式。
- 從產品銘牌的序號 (11) 即可確定您的測量工具機型。

## 裝入 / 更換電池

建議使用鹼性錳電池或鎳氫充電電池做為測量工具的電源（尤其是操作溫度偏低時）。

視電池容量而定，使用 1.2 伏特充電電池時的可測量次數可能會比使用 1.5 伏特電池來得少。

- » 打開電池盒蓋。
- » 裝入拋棄式電池或充電電池。

**i** 務必同時更換所有的拋棄式電池或充電電池。請使用同一製造廠商、容量相同的拋棄式電池或充電電池。

**i** 此時請您注意是否有依照電池盒內側上的電極標示正確放入。

拋棄式電池或充電電池進入低電量狀態時，將在顯示器上詢問您是否要啟用省電模式。使用省電模式可延長電池供電時間，螢幕上的電池符號將加註黃框。（參見「啟動／關閉省電模式」，頁 89）

螢幕中的電池符號一變成無格數後，您還可以進行少數幾次測量。

當電池符號處於無格數並呈紅色閃爍狀態時，則無法再進行測量。請您更換拋棄式電池或充電電池。

▶ **長時間不使用時，請將測量工具裡的拋棄式電池或充電電池取出。**經過長期存放，電池會腐蝕或自行放電。

- i** 請勿在未裝入電池盒蓋 (13) 或鋰離子充電電池組 (19) (配件) 的情況下為測量工具充電，尤其是在多塵或潮濕的環境中。

## 鋰離子充電電池組 (配件)

### 裝入 / 更換鋰離子充電電池組 (配件)

- » 請裝入鋰離子充電電池組 (19) (配件)。
- » 若要取下鋰離子充電電池組 (19) (配件)，請按下鎖扣 (20) 並取出鋰離子充電電池組。(參見 圖示 A, 頁 4)

### 為鋰離子充電電池組 (配件) 充電

- ▶ **充電時**，請使用建議使用的 USB 電源供應器或輸出電流和最小輸出電流符合「技術性數據」章節要求的電源供應器。請遵守 USB 電源供應器的操作說明書。  
建議使用的電源供應器；詳見「技術性數據」。
- ▶ **注意電源的電壓！** 電源的電壓必須和電源變壓器銘牌上標示的電壓一致。  
標示為 230 V 的電源變壓器亦可接上 220 V 電源。

- i** 由於國際運輸法規，鋰離子充電電池在出貨時為部分充電狀態。首度使用之前，請先將充電電池充飽電，以確保充電電池的完整功率。

用於連接 USB 連接線 (21) 的 USB 插孔和充電指示燈位於鋰離子充電電池組 (19) (配件) 上的 USB 插孔護蓋 (22) 下方。

- » 打開 Micro-USB 插孔護蓋 (22)。
- » 連接 USB 連接線 (21)。

在充電過程期間，顯示器中的電池電量指示器可能會與鋰離子充電電池組 (19) (配件) 的實際電量有偏差。

在充電期間，充電指示燈亮起黃色。

當鋰離子充電電池組 (19) (配件) 完全充電時，充電指示燈亮起綠色。



充電指示燈亮起紅色時，代表充電電壓或充電電流不合適。

## 操作

### 操作機器

- ▶ 不可放任啟動的測量工具無人看管，使用完畢後請關閉測量工具電源。雷射可能會對旁人的眼睛產生眩光。
- ▶ 不可以讓濕氣滲入儀器中，也不可以讓陽光直接照射在儀器上。
- ▶ 勿讓測量工具暴露於極端溫度或溫度劇烈變化的環境。例如請勿將它長時間放在車內。測量工具歷經較大溫度起伏時，請先讓它回溫後再使用。如果儀器曝露在極端溫度下或溫差較大的環境中，會影響儀器的測量準確度。
- ▶ 測量工具須避免猛力碰撞或翻倒。測量工具遭受外力衝擊後，一律必須先檢查其精準度（參見「準確度測試」，頁 104）並進行校正，然後才能繼續使用。



### 啟動 / 關閉

- » 按一下按鈕 ，即可開啟測量工具和雷射功能。  
您也可以透過按下按鈕  在沒有雷射的情況下開啟測量工具。
- » 按住按鈕 ，即可關閉測量工具。  
記憶體中的測量值及裝置設定將繼續留存。

### 探測程序

測量工具初次開機後的模式為長度測量功能。之後每一次開機時，測量工具將直接進入上一次使用的測量功能。

測量基準點共有三種不同設定。（參見「選擇基準點」，頁 86）

- » 將測量工具置於所需的測量起點上（例如：牆壁）。
- » 若您已使用按鈕  啟動測量工具，則短按按鈕 ，以啟動雷射。
- » 按一下按鈕 ，即可開啟測量程序。

測量過程結束後，雷射光束隨即關閉。若要進行另一次測量，請重複此程序。

測量值或最後的計算結果可進行加減。

原則上 0.5 秒鐘內就會出現測量值，最遲約 4 秒。

測量時間取決於距離、光線情況和目標物表面的反射特性。測量過程結束後，雷射光束隨即自動關閉。

**i** 進行測量期間，測量工具不得有任何移動（連續測量和傾角測量功能除外）。因此，請將測量工具儘可能放置在固定的擋塊或托架平面上。

**i** 測量時，接收點 (15) 和雷射光束出口 (16) 不得有遮蓋物。

### 影響測量範圍的因素

測量範圍取決於光線情況和目標物表面的反射特性。

有強烈外來燈光影響時，使用雷射眼鏡 (27) (配件) 和雷射標靶 (26) (配件) 可提高雷射光束的能見度，或遮掉目標物表面的光線。

### 影響測量結果的因素

由於物理作用之故，無法排除在不同類型表面上進行測量時出現誤差的狀況。表面的類型可分為：



- 透明表面（例如玻璃、水）
- 反射表面（例如拋光金屬、玻璃）
- 多孔狀表面（例如具有阻隔特性的材料）、
- 結構性表面（例如毛胚、天然石材）。

必要時請將雷射標靶 (26) (配件) 放到表面上。

如果未正確地瞄準好目標物表面，也可能會出現測量誤差。此外有溫差的空氣層和間接反射都可能影響測量值。

## 功能表導覽

在功能表中，您可以使用按鈕  切換到右側，使用按鈕  切換到左側。

如需確定選擇，請按下按鈕  或按鈕 。

若要離開功能表，請按一下按鈕 。

## 選擇基準點

測量時有不同基準點供您選擇：



測量工具後緣（例如貼靠在牆面上時）





三腳架螺紋孔 (14) 的中心 (例如使用三腳架測量時)



測量工具前緣 (例如：以桌緣做為測量起點)

» 按一下按鈕 ，即可開啟**基本設定**功能表。

» 請選擇 。

» 請使用按鈕  或按鈕  選擇所需的基準點。











» 請按一下按鈕 ，以確定選擇。

測量工具每次啟動之後，將預設為上一次選取的基準點。



無法在已成功測量 (例如於測量值列表中顯示測量值時) 之後變更基準點。



## 基本設定選單

在**基本設定**功能表可找到以下基本設定：

-  切換基準點 (參見「選擇基準點」，頁 86)
-  啟動／關閉聲音訊號
-  啟動／關閉振動訊號
-  設定顯示器亮度
-  啟動／關閉省電模式
-  切換尺寸單位
-  設定語言
-  校正傾角測量 (參見「準確度測試」，頁 104)
-  開啟裝置資訊
-  原廠設定
-  清除所有記憶體









» 按一下按鈕 ，即可開啟**基本設定**功能表。

» 請利用按鈕  或按鈕  選擇所需設定。

- » 如需確定選擇，請按下按鈕  或按鈕 。
- » 若要退出**基本設定**功能表，短按按鈕 。

### 啟動 / 關閉聲音訊號









您可在基本設定中開啟音效。

- » 按一下按鈕 ，即可開啟**基本設定**  功能表。
  - » 請選擇 。
  - » 按下按鈕  或按鈕 ，即可變更選擇。
  - » 如需確定選擇，請按下按鈕  或按鈕 。
  - » 若要退出**基本設定**  功能表，短按按鈕 。
- 測量工具關機後，所選之設定仍將保留。

### 啟動 / 關閉振動訊號



您可在基本設定中開啟振動訊號。

舉例來說，測量工具的振動訊號在吵雜環境中可以發揮很大的幫助。連續兩次短暫振動代表測量成功；單次較長時間振動則是代表測量發生錯誤。







- » 按一下按鈕 ，即可開啟**基本設定**  功能表。
  - » 請選擇 。
  - » 按下按鈕  或按鈕 ，即可變更選擇。
  - » 如需確定選擇，請按下按鈕  或按鈕 。
  - » 若要退出**基本設定**  功能表，短按按鈕 。
- 測量工具關機後，所選之設定仍將保留。

### 設定顯示器亮度

螢幕可配合環境條件調成不同的亮度等級。









- » 按一下按鈕 ，即可開啟**基本設定**  功能表。
- » 請選擇 。



- » 按下按鈕  或按鈕 ，即可變更選擇。
  - » 如需確定選擇，請按下按鈕  或按鈕 。
  - » 若要退出**基本設定**  功能表，短按按鈕 。
- 測量工具關機後，所選之設定仍將保留。









### 啟動 / 關閉省電模式

您可在基本設定中關閉省電模式。省電模式開啟時，將停用音效和振動訊號，並且降低螢幕亮度。藉此延長電池供電時間。

- » 按一下按鈕 ，即可開啟**基本設定**  功能表。
  - » 請選擇 。
  - » 按下按鈕  或按鈕 ，即可變更選擇。
  - » 如需確定選擇，請按下按鈕  或按鈕 。
  - » 若要退出**基本設定**  功能表，短按按鈕 。
- 測量工具關機後，所選之設定仍將保留。











### 切換尺寸單位

基本設定中的尺寸單位為「m」（公尺）。本機共有六種不同計量單位供您選用。請依據您的需要設定適合的計量單位。

- » 按一下按鈕 ，即可開啟**基本設定**  功能表。
  - » 請選擇 。
  - » 按下按鈕  或按鈕 ，即可變更選擇。
  - » 如需確定選擇，請按下按鈕  或按鈕 。
  - » 若要退出**基本設定**  功能表，短按按鈕 。
- 測量工具關機後，所選之設定仍將保留。







### 設定語言

測量工具初次開機時，系統將要求您設定螢幕文字的偏好使用語言。您隨時可以變更介面使用的語言。

- » 按一下按鈕 ，即可開啟**基本設定**  功能表。
- » 選擇  進行更多設定。
- » 請選擇 。
- » 按下按鈕  或按鈕 ，即可變更選擇。
- » 如需確定選擇，請按下按鈕  或按鈕 。
- » 若要退出**基本設定**  功能表，短按按鈕 。  
測量工具關機後，所選之設定仍將保留。









### 裝置資訊

此處將為您提供測量工具的序號、軟體版本和授權等相關資訊。

- » 按一下按鈕 ，即可開啟**基本設定**  功能表。
- » 選擇  進行更多設定。
- » 請選擇 。
- » 若要退出**基本設定**  功能表，短按按鈕 。







### 恢復出廠預設值

本項功能是用來將測量工具重設回原廠設定／重設基本設定。重設後，系統將要求您設定螢幕的偏好使用語言。

- » 按一下按鈕 ，即可開啟**基本設定**  功能表。
- » 選擇  進行更多設定。
- » 請選擇 。
- » 若要重置測量工具，請選擇  並以按鈕  或按鈕  確認。
- » 若要退出**基本設定**  功能表，短按按鈕 。

### 清除所有記憶體













- » 按一下按鈕 ，即可開啟**基本設定**  功能表。





- » 選擇  進行更多設定。
- » 請選擇 。
- » 若要刪除記憶體，請以按鈕  或按鈕  選擇 ，並以按鈕  或按鈕  確認。  
這將刪除所有測量值。

## 測量功能

### 選擇 / 更改測量功能

您可在功能選單中找到以下功能：

-  長度測量
-  連續測量
-  面積測量
-  體積測量
-  間接長度測量
  -  間接高度測量
  -  雙重間接高度測量
  -  間接長度測量
-  牆壁面積測量
-  定樁
-  傾角測量 / 數位水平儀
-  儲存功能

- » 按一下按鈕 ，即可開啟 **功能** 功能表。
- » 請利用按鈕  或按鈕  選擇所需的測量功能。
- » 如需確定選擇，請按下按鈕  或按鈕 。

## 整合式輔助說明功能？

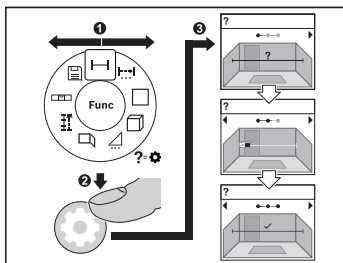

測量工具中的整合式輔助說明功能為所有測量功能／測量流程提供動態圖示。

- » 請打開**功能**功能表。
- » 請利用按鈕 或按鈕 並按下按鈕 選擇所需的**功能**。  
即會顯示關於所選測量功能的詳細操作方式動態圖示。
- » 按一下 或 按鈕，即可顯示

下一步或上一步。

## 長度測量

- » 按一下按鈕 ，即可開啟**功能**功能表。
- » 請選擇長度測量 並利用按鈕 確定選擇。
- » 請短按按鈕 ，即可開啟雷射功能。
- » 按一下按鈕 ，即可開啟測量程序。

測量值將出現在螢幕下方測量結果顯示列 (e)。

- » 每一次想要重新進行測量時，請重複上述步驟。

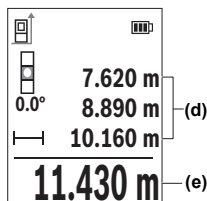

連續進行多次長度測量時，最新的測量結果將出現在測量值顯示列 (d) 中。最新測量值將出現在螢幕下方，而前一次的測量值則位於其上，依此類推。

## 面積測量

- » 按一下按鈕 **Func**，即可開啟 **功能** 功能表。
- » 請選擇面積測量  並利用按鈕 **Func** 確定選擇。
- » 請短按按鈕 **▲**，即可開啟雷射功能。
- » 按一下按鈕 **▲**，即可開啟第一次測量程序，例如空間長度。
- » 按一下按鈕 **▲**，即可開啟第二次測量程序，例如空間寬度。

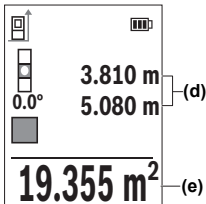

完成第二次測量後，將自動計算出面積並於畫面中顯示該值。結果將顯示於測量結果顯示列 (e) 中。測量值顯示列 (d) 中將詳列出每一個測量值。

## 連續測量 $\leftarrow \rightarrow$

在連續測量的情況下，測量值會不斷更新。舉例來說，您可從某一個牆面離開，走到相隔所需距離的位置，期間可隨時看到當下的實際距離。  
連續測量可採用三項功能，在螢幕上個別顯示不同的測量形式：

### 最小 / 最大 $\frac{\min}{\max}$

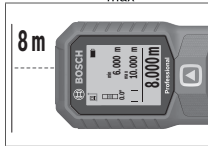

持續在螢幕上為您顯示最小及最大測量值。

- » 按一下按鈕 **Func**，即可開啟**功能**功能表。
- » 請在功能表項目連續測量  $\leftarrow \rightarrow$  選擇最小/最大  $\frac{\min}{\max}$ ，並使用按鈕 **Func** 確定選擇。
- » 請短按按鈕 **▲**，即可開啟雷射功能。
- » 移動測量工具，直至所需距離出現在測量結果顯示列為止。  
您可以透過短按按鈕 **▲** 來中斷連續測量。
- » 重新按下按鈕 **▲**，即可繼續連續測量。

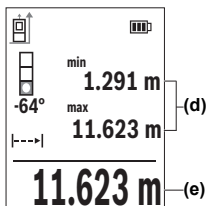

最新的測量值會顯示在測量結果顯示列 (e) 中，最大和最小測量值會顯示在測量值顯示列 (d) 中。

### 大數字 0<sup>+</sup>

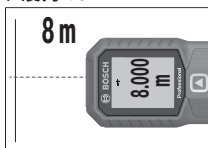

為了方便讀取，測量值將以較大字體顯示。

### 捲尺

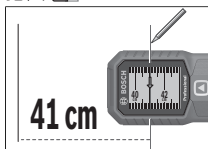





距離會如同使用捲尺時一樣呈現。

 在捲尺功能中，基準點是螢幕中所顯示的標記。基準點不是測量工具的邊緣。

連續測量功能將於 4 分鐘後自動關閉。

### 體積測量

- » 按一下按鈕 ，即可開啟 **功能** 功能表。
- » 請選擇體積測量  並利用按鈕  確定選擇。
- » 請短按按鈕 ，即可開啟雷射功能。
- » 按一下按鈕 ，即可開啟第一次測量程序，例如空間長度。

» 按一下按鈕 ▲，即可開啟第二次測量程序，例如空間寬度。

» 按一下按鈕 ▲，即可開啟第三次測量程序，例如空間長度。

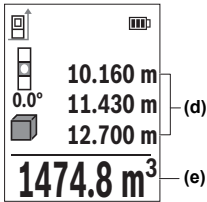

完成第三次測量後，測量工具將自動計算出體積並於畫面中顯示該值。結果將顯示於測量結果顯示列 (e) 中。測量值顯示列 (d) 中將詳列出每一個測量值。

### 間接長度測量



無法進行直接測量時（例如有障礙物會阻擋雷射，或者沒有目標物可充當反射體時），則必須以間接的方式測量。此一測量方式僅適用於垂直方向。任何水平方向的偏差都會導致測量誤差。

間接距離測量的精準度永遠不如直接距離測量。視運用方式而定，其測量誤差可能大於直接距離測量。為改善測量準確度，建議您使用三腳架（配件）。

 使用三腳架時，請注意所設定的基準點。（參見「選擇基準點」，頁 86）

雷射將在各次單一測量之間的空檔保持開啟。

間接距離測量共分為 3 種測量功能供您選用，它們分別可用來量測不同類型的距離。





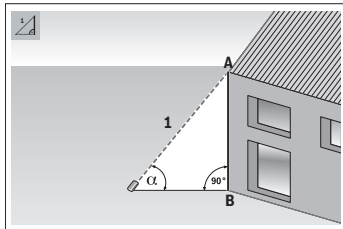

-  間接高度測量
-  雙重間接高度測量
-  間接長度測量

### 間接高度測量



利用間接高度測量，您可藉由測量線段 **1** 來測得線段 **AB**。測量工具根據角度  $\alpha$  和線段 **1** 計算所需的高度 **AB**。

進行每一次測量時，雷射與待測量線段必須一直保持直角，這樣測量結果才正確。

- » 按一下按鈕 ，即可開啟 **功能** 功能表。
- » 請選擇間接距離測量  並利用按鈕  確定選擇。
- » 請選擇高度距離  並利用按鈕  確定選擇。
- » 請短按按鈕 ，即可開啟雷射功能。
- » 將測量工具放在下方測量點 **B** 的高度上。
- » 傾斜測量工具，使雷射對準上方測量點 **A**。
- » 按一下按鈕 ，即可開啟測量程序。

完成測量後，將自動計算出高度並於測量結果顯示列 **(e)** 中顯示該值。**1** 線段及  $\alpha$  角的測量值則是位於測量值顯示列 **(d)** 中。

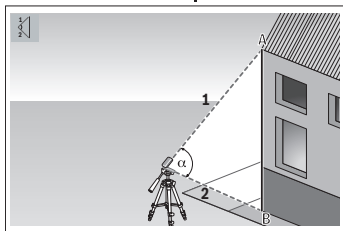

### 雙重間接高度測量



利用雙重間接高度測量，您可藉由測量線段 **1** 和 **2** 來測得線段 **AB**。測量工具根據角度  $\alpha$  和線段 **1** 和 **2** 計算所需的高度 **AB**。



建議使用三腳架進行此測量。



- » 按一下按鈕 **Func**，即可開啟 **功能** 功能表。
- » 請選擇間接距離測量  並利用按鈕 **Func** 確定選擇。
- » 請選擇雙重間接高度測量  並利用按鈕 **Func** 確定選擇。
- » 請短按按鈕 **▲**，即可開啟雷射功能。
- » 傾斜測量工具，使雷射對準上方測量點 **A**。
- » 按一下按鈕 **▲**，即可開啟第一次測量程序。
- » 傾斜測量工具，使雷射對準下方測量點 **A**。不要改變測量工具的位置。
- » 按一下按鈕 **▲**，即可開啟第二次測量程序。

完成測量後，將自動計算出高度並於測量結果顯示列 **(e)** 中顯示該值。1、2 線段及  $\alpha$  角的測量值則是位於測量值顯示列 **(d)** 中。

### 間接長度測量

- » 按一下按鈕 **Func**，即可開啟 **功能** 功能表。
- » 請選擇間接距離測量  並利用按鈕 **Func** 確定選擇。
- » 請選擇長度測量  並利用按鈕 **Func** 確定選擇。
- » 將測量工具放在所求線段 **AB** 的起點 **A** 上。
- » 傾斜測量工具，以使雷射對準終點 **B** 所在的平面。
- » 按一下按鈕 **▲**，即可開啟測量程序。

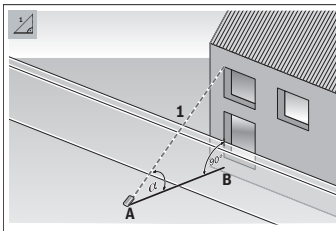



利用間接長度測量，您可藉由測量線段 **1** 來測得線段 **AB**。測量工具根據角度  $\alpha$  和線段 **1** 計算所需的長度 **AB**。

完成測量後，將自動計算出長度並於測量結果顯示列 (e) 中顯示該值。1 線段及  $\alpha$  角的測量值則是位於測量值顯示列 (d) 中。

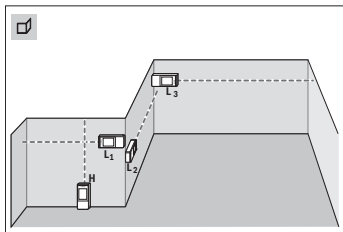
### 牆壁面積測量



牆壁面積測量是用來計算相同高度之數個單一牆面的總面積。為求正確計算面積，其前提是：所有區塊面積的第一個測量長度要一致（在本範例中即為空間高度  $H$ ）。插圖範例中所測量的是：空間高度  $H$  相同但長度不同  $L$  之多個牆面加總起來的總面積。

- » 按一下按鈕 ，即可開啟 **功能** 功能表。
- » 請選擇牆壁面積測量  並利用按鈕  確定選擇。
- » 依照進行長度測量之方式來測量空間高度  $H$ 。  
測量值將顯示於上方測量值列。雷射功能將保持開啟。
- » 隨後請測量第一面牆的長度  $L_1$ 。  
將自動計算出面積並於測量結果顯示列 **d** 中顯示該值。最新得出的長度測量值位於下方測量值列。雷射功能將保持開啟。
- » 現在請您測量第二面牆的長度  $L_2$ 。

您可以繼續測量任意多個長度  $LX$ ，系統會自動相加這些值後再乘以高度  $H$ 。測量值列 (d) 中所顯示的單次測量值將累加於長度  $L_1$  中。兩個長度（顯示於中間測量值列 (d)）加總後再乘以之前儲存的高度  $H$ 。所得的總面積值將顯示於螢幕下方測量結果顯示列 (e)。

### 定標

- (i) 在放樣功能中，基準點是螢幕中顯示的標記。基準點不是測量工具的邊緣。

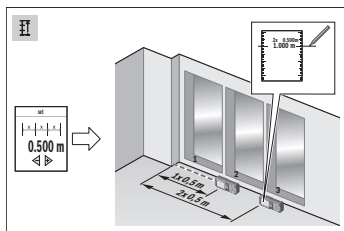

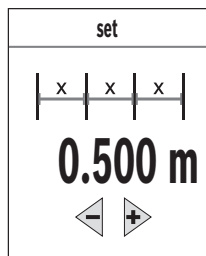

放樣功能可重複測量一個自訂長度（距離）。您可將此長度移植到任一表面上，以便將材料切成相同長度或建構石膏隔間牆等等。可設定的最小長度為 0.1 m，可設定的最大長度為 50 m。



» 按一下按鈕 **Func**，即可開啟**功能**功能表。

» 請選擇放樣功能  並利用按鈕 **Func** 確定選擇。

» 請利用按鈕  或按鈕  設定所需長度。

按住按鈕  或按鈕 ，即可以更大幅度更改長度。

» 按一下按鈕 ，即可啟動放樣功能並慢慢遠離起始點。

測量工具將持續測量目前與起點之間的問題。此時將同時顯示您的自訂長度以及目前測量值。向下或向上箭頭表示：到下一個或上一個記號的最短距離。



位於左邊的係數代表已達到距離換算為自訂長度的倍數。螢幕兩旁的綠線則是告知達到標記目的之長度。

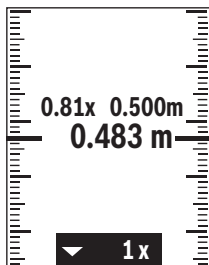



當參照值不在螢幕範圍上，藍線和藍色字樣則顯示實際值。

### 傾角測量 / 數位水平儀

數位水平儀是用來檢查某一物體的水平或垂直定位（例如洗衣機、冰箱等等）。傾角測量則是用來測量坡度或傾斜度（例如用於樓梯、欄杆、家具榫接、管路鋪設等等）。當您改變測量工具的位置時，測量工具會自動在兩種功能之間切換。

» 按一下按鈕 ，即可開啟 **功能** 功能表。

» 請選擇傾角測量 / 數位水平儀  並利用按鈕  確定選擇。

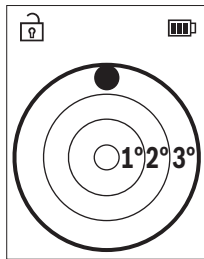

數位水平儀的基準點為測量工具底部。

» 若要使用數位水平儀，請將測量工具的背面放在待測量的表面上。

您可按下按鈕  來凍結測量值。

» 傾斜度若超過 3°，螢幕上的圓球將以紅色顯示。

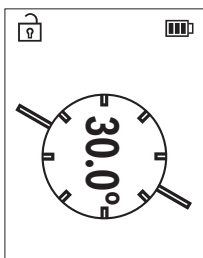





測量工具的左側為傾角測量的基準點。測量中途如果此符號開始閃爍，代表測量工具過度側傾。

» 若要使用傾角測量，請將測量工具的側面放在待測量傾角的物體上。

您可按下按鈕 ▲ 來凍結測量值。

## 儲存功能

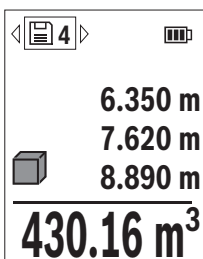

每次完成測量後，將自動儲存測量值或最後的計算結果。最後的 **30** 值會被儲存（測量值或最終結果）。若記憶體已滿，則會覆寫最舊的值。最舊數值位於記憶體中的第 1 筆資料；最新數值則是位於第 **30** 筆資料（儲存值達 **30** 筆時）。

- » 按一下按鈕 ，即可開啟**功能**功能表。
- » 請選擇儲存功能  並利用按鈕  確定選擇。  
其將顯示最後一個值。
- » 請按一下按鈕  或按鈕 ，即可瀏覽至其他儲存值。



螢幕上方所顯示的是所儲存之數值的編號，相關測量功能的符號則顯示在左側。如果記憶體中沒有數值，螢幕下方將出現「0.000」而上方則是出現「0」。

## 刪除儲存值

- » 若要刪除所顯示的數值，按一下按鈕 。
- » 按一下按鈕  以確認。

若要刪除所有儲存值，請在 **基本設定**  功能表中選擇 **刪除所有記憶** 選單項目。(參見「清除所有記憶體 」，頁 90)



## 數值相加 / 相減

### 長度測量時相加數值

- » 請選擇長度測量功能。
- » 進行第一次測量。
- » 按一下按鈕 。
- » 進行第二次測量。

第二次測量完成後，第二次測量的結果將顯示在測量值顯示列 (d)，最終結果顯示在測量結果顯示列 (e) 中。

### 面積和體積測量時相加數值

- » 請選擇面積測量或體積測量的功能。
- » 進行第一次面積測量或體積測量。
- » 按一下按鈕 。
- » 進行第二次面積測量或體積測量。  
一旦完成第二次或第三次測量，就會自動計算並顯示面積或體積。結果將顯示於測量結果顯示列 (e) 中。測量值顯示列 (d) 中將詳列出每一個測量值。
- » 按一下按鈕 ，即可顯示加總的最終結果。

最終結果將顯示於測量結果顯示列 (e) 中。各面積或體積測量的結果顯示在測量值顯示列 (d) 中。

## 數值相減

» 若要將數值相減，請按一下按鈕 。後續步驟請比照「數值相加」。

## 刪除測量值

所有測量功能均可透過短按  按鈕刪除最後測得的測量值。

多次短按該按鈕 ，即能反序刪除測量值。

## 藍牙® 介面

### 將資料傳輸至其他裝置

本測量工具配備藍牙® 模組，透過此一無線技術即可與具有藍牙® 介面的特定行動終端裝置進行資料傳輸（例如智慧型手機、平板電腦）。

如需藍牙® 連線的最低系統需求相關資訊，請至博世網站：  
www.bosch-pt.com。

► 如需其他資訊，請參考博世產品說明頁。

透過藍牙® 進行資料傳輸時，行動終端裝置與測量工具之間可能有時間遲滯的現象。問題可能是出在兩個裝置之間的距離或是出在測量目標物本身。

### 啟用行動終端裝置的藍牙® 介面，以便進行資料傳輸

✓ 請確認：行動終端裝置上的藍牙® 介面已啟用。

» 按一下按鈕 ，即可開啟藍牙® 功能表。

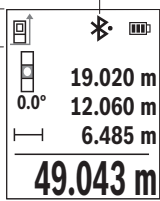

» 重新按一下按鈕 ，以啟動藍牙® 介面。

(b) 連線狀態以及啟用之連線 (b) 將顯示於測量工具的狀態列 (h) 中。

(h)  本公司提供博世應用程式，可為您擴充本電動工具的功能。您可到相關 App 商店按照所使用的終端裝置下載該程式。

博世應用程式啟動之後，將為您於終端行動裝置與測量工具之間自動建立連線。萬一同時找到多個啟用的測量工具，請您根據序號選擇相符的那一個測量工具。序號 (11) 位於測量工具的產品銘牌上。

## 停用藍牙® 介面

- » 按下按鈕 ，以開啟藍牙® 功能表，然後重新按一下按鈕 ，以停用藍牙® 介面。



## 準確度測試

請定期檢查傾角測量和距離測量的準確度。

### 傾角測量準確度檢查

- » 請將測量工具放到桌上，然後進行傾角測量。
- » 將測量工具旋轉 180°，然後再測量一次傾角。  
顯示值最多可相差 0.3°。

如果差距超出規定則必須重新校正測量工具。

- » 按一下按鈕 ，即可開啟**基本設定**功能表。
- » 請選擇  並利用按鈕  確定選擇。
- » 並遵照螢幕上的指示。

 本測試工具經歷溫度劇烈變化或碰撞之後，建議您進行準確度測試，並視需要執行校正。本測試工具經歷溫度劇烈變化或碰撞之後，必須先回溫一段時間然後才進行校正。

### 檢查距離測量準確度

該準確度檢查應在有利條件下進行，亦即該測量長度位於室內、測量目標物的表面光滑且具有良好反射性（例如白漆牆）。

- » 選擇一條您本人非常熟悉、長度在 **3 至 10 m** 之間的測量線段（例如房間的寬度，門口等）。
- » 連續測量該線段 10 次。  
在有利條件下，在整個測量區段上，單次測量值與準確已知尺寸的偏差不得超過  $\pm 2$  mm。請做好測量記錄，以便日後充當檢查儀器準確度的根據。

## 使用三腳架 (配件) 進行測量

當測量目標位於遠處時，三腳架非常實用。



- » 請利用 1/4" 螺紋孔 (14) 將測量工具安裝到三腳架 (25) 或一般市售相機三腳架的快拆座上。
- » 擰緊快速更換盤上的固定螺絲以便固定好測量儀器。
- » 選好使用三腳架時的測量基準點 (參見「選擇基準點」, 頁 86)。

## 腰帶夾

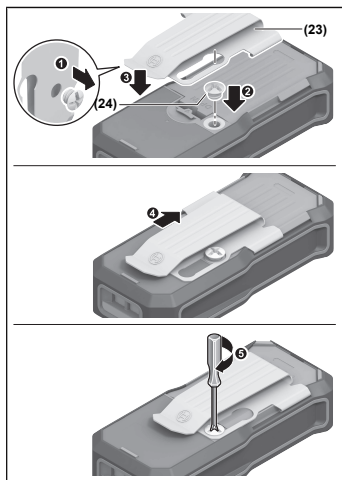

利用腰帶夾 (23) 即可很方便地將測量工具掛在你的腰帶上。  
若要在測量工具上安裝腰帶夾, 請遵循圖示中的步驟。

## 故障訊息

如果無法正確執行測量程序, 螢幕上將出現故障訊息 **Error**。

- » 請嘗試重新執行測量過程。
- » 如果故障訊息再次出現, 請關閉測量工具、再次啟動並重新開始測量。



測量工具在進行每次測量時會監控功能是否正常。若確認出現故障, 螢幕上僅會出現左側符號, 隨後測量工具將自動關機。發生這

種情況時，請將該測量工具交由您的經銷商轉送至博世顧客服務處。

## 維修和服務

### 保養與清潔

儲放和搬運測量工具時，一定要將它放置在隨附的保護套袋內。

測量儀器必須隨時保持清潔。

不可以把儀器放入水或其它的液體中。

使用柔軟濕布擦除儀器上的污垢。切勿使用清潔劑或溶液。

進行保養時需格外小心接收點 (15)，務必請您比照眼鏡或攝影鏡頭的處置方式。

如需送修，請將測量工具放入保護套袋 (18) 內後，再轉交給相關單位。

### 顧客服務處和顧客諮詢中心

本公司顧客服務處負責回答有關本公司產品的維修、維護和備用零件的問題。

以下的網頁中有分解圖和備用零件相關資料：[www.bosch-pt.com](http://www.bosch-pt.com)

如果對本公司產品及其配件有任何疑問，博世應用諮詢小組很樂意為您提供協助。

當您需要諮詢或訂購備用零件時，請務必提供本產品型號銘牌上 10 位數的產品機號。

#### 台灣

台灣羅伯特博世股份有限公司

建國北路一段90 號6 樓

台北市10491

電話: (02) 7734 2588

傳真: (02) 2516 1176

[www.bosch-pt.com.tw](http://www.bosch-pt.com.tw)

#### 制造商地址:

Robert Bosch Power Tools GmbH

羅伯特· 博世電動工具有限公司

70538 Stuttgart / GERMANY

70538 斯圖加特/ 德國

#### 以下更多客戶服務處地址：

[www.bosch-pt.com/serviceaddresses](http://www.bosch-pt.com/serviceaddresses)

## 搬運

建議使用的鋰離子充電電池受危險物品法的規範。使用者無須另外使用保護包裝便可運送該充電電池。

但是如果將它交由第三者運送（例如：寄空運或委託運輸公司），則應遵照包裝與標示的相關要求。此時必須向危險物品專家請教有關寄送危險物品的相關事宜。

確定充電電池的外殼未受損後，才可以寄送充電電池。用膠帶貼住裸露的接點並妥善包裝充電電池，不可以讓充電電池在包裝材料中晃動。同時也應留意各國相關法規。

## 廢棄物處理



測量工具、充電電池／拋棄式電池、配件以及包裝材料須遵照環保相關法規進行資源回收。



不得將本測量工具與充電電池／拋棄式電池丟入家庭垃圾中！

### 充電電池 / 一般電池：

#### 鋰離子：

請注意「搬運」段落中的指示(參見「搬運」，頁 107)。

## 有關台灣的更多資訊

### NCC 警語

#### 低功率射頻器材管理辦法:

取得審驗證明之低功率射頻器材，非經核准，公司、商號或使用者均不得擅自變更頻率、加大功率或變更原設計之特性及功能。

低功率射頻器材之使用不得影響飛航安全及干擾合法通信；經發現有干擾現象時，應立即停用，並改善至無干擾時方得繼續使用。

前述合法通信，指依電信管理法規定作業之無線電通信。

低功率射頻器材須忍受合法通信或工業、科學及醫療用電波輻射性電機設備之干擾。

## 配件

您可以使用提供的連結在博世網站上找到配件



BA 3.7V 1.0Ah A (19)  
1 608 M00 C5D

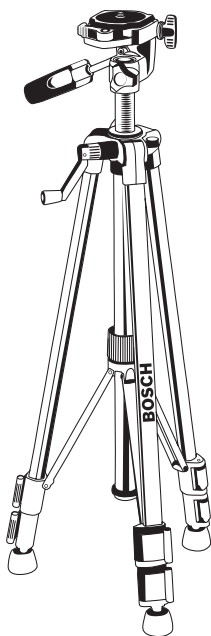

三腳架 BT 150 (25)  
0 601 096 B00

雷射標靶 (26)

2 607 001 391

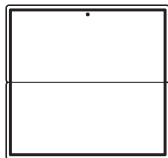

雷射辨識鏡 (綠色) (27)

1 608 M00 05J

## 한국어

### 안전 수칙



축정공구의 안전한 사용을 위해 모든 수칙들을 숙지하고 이에 유의하여 작업하시기 바랍니다. 축정공구를 해당 지침에 따라 사용하지 않으면, 축정공구에 내장되어 있는 안전장치에 안 좋은 영향을 미칠 수 있습니다. 축정공구의 경고판을 철대로 가려서는 안 됩니다. 안전 수칙을 잘 보관하고 공구 양도 시 축정공구와 함께 전달하십시오.

- ▶ 주의 - 여기에 제시된 조작 장치 또는 조정 장치 외의 용도로 사용하거나 다른 방식으로 작업을 진행하는 경우, 광선으로 인해 폭발될 위험이 있습니다.
- ▶ 본 축정공구는 레이저 경고 스티커가 함께 공급됩니다(그림에 축정공구의 주요 명칭 표시).
- ▶ 처음 사용하기 전에 함께 공급되는 한국어로 된 레이저 경고 스티커를 독문 경고판 위에 붙이십시오.



사람이나 동물에게 레이저 광선을 비추거나, 광선을 직접 또는 반사시켜 보지 마십시오. 이로 인해 눈이 부시게 만들어 사고를 유발하거나 눈에 손상을 입을 수 있습니다.

- ▶ 눈으로 레이저 광선을 쳐다본 경우, 의식적으로 눈을 감고 곧바로 고개를 돌려 광선을 피하십시오.
- ▶ 레이저 장치를 개조하지 마십시오.
- ▶ 측정공구의 수리는 해당 자격을 갖춘 전문 인력에게 맡기고, 수리 정비 시 순정 부품만 사용하십시오. 이 경우에만 측정공구의 안전성을 오래 유지할 수 있습니다.
- ▶ 어린이가 무감각 상태로 레이저 측정공구를 사용하는 일이 없도록 하십시오. 의도치 않게 타인 또는 자신의 눈이 부시게 할 수 있습니다.
- ▶ 가연성 유체나 가스 혹은 분진 등 폭발 위험이 있는 곳에서 측정공구를 사용하지 마십시오. 측정공구에 분진이나 증기를 접착하는 스파크가 생길 수 있습니다.
- ▶ 배터리를 분해하지 마십시오. 단락이 발생할 위험이 있습니다.
- ▶ 배터리가 손상되었거나 잘못 사용될 경우 증기가 발생할 수 있습니다. 배터리에서 화재가 발생하거나 폭발할 수 있습니다. 작업장을 환기시키고, 필요한 경우 의사와 상담하십시오. 증기로 인해 호흡기가 자극될 수 있습니다.
- ▶ 배터리를 잘못 사용거나 배터리가 손상된 경우, 배터리에서 가연성 유체가 흘러나올 수 있습니다. 누수가 생긴 배터리에 닿지 않도록 하십시오. 피부에 접하게 되었을 경우 즉시 물로 씻으십시오. 유체가 눈에 닿았을 경우 바로 의사와 상담하십시오. 배터리에서 나오는 유체는 피부에 자극을 주거나 화상을 입힐 수 있습니다.
- ▶ 못이나 스크류 드라이버 같은 뾰족한 물체 또는 외부에서 오는 충격 등으로 인해 축전지가 손상될 수 있습니다. 내부 단락이 발생하여 배터리가 타거나 연기가 발생하고, 폭발 또는 과열될 수 있습니다.
- ▶ 배터리를 사용하지 않을 때는 각 극 사이에 브리징 상태가 생길 수 있으므로 페이퍼 클립, 동전, 열쇠, 못, 나사 등 유사한 금속성 물체와 멀리하여 보관하십시오. 배터리 극 사이에 쇼트가 일어나 화상을 입거나 화재를 야기할 수 있습니다.
- ▶ 제조사의 배터리 제품만 사용하십시오. 그래야만 배터리 과부하의 위험을 방지할 수 있습니다.
- ▶ 배터리는 제조사에서 권장하는 충전기에만 충전하십시오. 특정 제품의 배터리를 위하여 제조된 충전기에 적합하지 않은 다른 배터리를 충전할 경우 화재 위험이 있습니다.



배터리를 태양 광선 등 고열에 장시간 노출되지 않도록 하고 불과 오염물질, 물, 수분이 있는 곳에 두지 마십시오. 폭발 및 단락의 위험이 있습니다.



- ▶ 레이저 보안경(액세서리)을 일반 보안경으로 사용하지 마십시오. 레이저 보안경은 레이저 광선을 보다 잘 감지하지만, 그렇다고 해서 레이저 광선으로부터 보호해주는 것은 아닙니다.
- ▶ 레이저 보안경(액세서리)을 선글라스 옹도 또는 도로에서 사용하지 마십시오. 레이저 보안경은 자외선을 완벽하게 차단하지 못하며, 색상 분별력을 떨어뜨립니다.
- ▶ 해당 무선설비는 전파통신 가능성이 있으므로 인명안전 과 관련된 서비스 는 할 수 없습니다 .
- ▶ 측정공구에는 무선 인터페이스가 장착되어 있습니다. 비행기나 병원 등 장소에 따른 제약에 주의하십시오.

블루투스® 워드마크와 그림(로고)은 Bluetooth SIG, Inc.의 등록상표입니다. Robert Bosch Power Tools GmbH는 허가를 받아 이를 사용하고 있습니다.

- ▶ 주의 측정공구의 블루투스® 사용은 다른 기기나 설비, 비행기 및 의료기 기(예: 심박 조정기,보청기) 등에 장애를 가져올 수 있습니다. 마찬가지로 근처에 있는 동물이나 사람에게도 좋지 않은 영향을 미칠 수 있습니다. 측정공구의 블루투스® 사용은 의료 기기, 주유소, 화학설비 및 폭발 위험이 있는 주변에서는 삼가하십시오. 비행기에서 측정공구의 블루투스® 사용은 삼가하십시오. 오랜 시간 신체에 직접 접촉하여 작동하는 것을 삼가하십시오.

## 전원 플러그 관련 안전 수칙

- ▶ 본 전원 플러그는 어린이나 정신지체 및 신체 부자유자 혹은 경험이나 지식이 부족한 사람이 사용하기에 적합하지 않습니다. 본 전원 플러그는 안전 책임자의 감독 하에 혹은 감독자에게 전원 플러그의 안전한 사용법과 관련 위험사항에 대한 교육을 받고 이해한 경우에 한해 8세 이상의 어린이, 정신지체 및 신체 부자유자 혹은 경험이나 지식이 부족한 사람이 사용할 수 있습니다. 이를 지키지 않을 경우, 오작동과 부상의 위험이 따릅니다.



전원 플러그가 비에 맞지 않게 하고 습기 있는 곳에 두지 마십시오. 전원 플러그에 물이 들어가면 감전될 위험이 높습니다.

- ▶ 전원 플러그를 깨끗하게 유지하십시오. 오염으로 인해 감전이 발생할 수 있습니다.

- ▶ 사용하기 전에 항상 전원부를 점검하십시오. 손상된 부위가 발견되면 전원부를 사용하지 마십시오. 전원부는 스스로 직접 분해하지 말고 공인된 Bosch 고객 서비스 센터에만 맡기고 순정 대체품으로만 수리하십시오. 손상된 전원부는 감전을 일으킬 위험이 높습니다.

## 제품 및 성능 설명

### 규정에 따른 사용







본 측정공구는 거리, 길이, 높이, 간격, 경사도를 측정하고 면적 및 체적을 계산하는 데 사용됩니다.

측정공구는 실내용입니다.

측정 결과는 블루투스®를 통해 다른 장치로 전송할 수 있습니다.

### 제품의 주요 명칭

제품의 주요 명칭에 표기되어 있는 번호는 측정공구의 그림이 나와있는 면을 참고하십시오.

- (1)  블루투스® 버튼
- (2)  기능 버튼
- (3)  마이너스 버튼
- (4) 디스플레이
- (5)  측정 버튼
- (6)  플러스 버튼
- (7)  기본 설정 버튼
- (8)  전원/위로 가기 버튼
- (9) 운반 고리 삽입부
- (10) 레이저 경고판
- (11) 일련 번호
- (12) 배터리 케이스 덮개 잠금쇠
- (13) 배터리 케이스 덮개
- (14) 1/4" 삼각대 소켓



- (15) 수신 렌즈
- (16) 레이저빔 발사구
- (17) 운반 고리<sup>A)</sup>
- (18) 안전 케이스
- (19) 리튬 이온 배터리팩<sup>A)</sup>
- (20) 리튬 이온 배터리팩 잠금쇠<sup>A)</sup>
- (21) USB Type-C® 케이블<sup>A)B)</sup>
- (22) USB 포트 커버<sup>A)</sup>
- (23) 벨트 클립<sup>A)</sup>
- (24) 벨트 클립용 나사<sup>A)</sup>
- (25) 삼각대<sup>A)</sup>
- (26) 레이저 포적판<sup>A)</sup>
- (27) 레이저 보안경<sup>A)</sup>

A) 도면이나 설명서에 나와있는 액세서리는 표준 공급부품에 속하지 않습니다. 전체 액세서리는 저희 액세서리 프로그램을 참고하십시오.

B) USB Type-C® 및 USB-C®는 USB Implementers Forum의 상표입니다.

### 표시 요소

- (a) 측정 기준 레벨
- (b) 블루투스® 상태
  - \* 블루투스® 작동, 연결되지 않음
  - \* 블루투스® 작동, 연결됨
- (c) 배터리 표시기
- (d) 측정값 표시열
- (e) 결과 표시열
- (f) 측정 기능 표시
- (g) 경사각도 표시
- (h) 상태 바
- (i) 기능 메뉴

- (j) 기본 설정 메뉴
- (k) 세부 기본 설정 메뉴

## 제품 사양

디지털 레이저 거리 측정기	GLM 50-27 CG
품번	<b>3 601 K72 U..</b>
측정 영역 <sup>A)</sup>	0.05-50 m
측정 영역(부적절한 조건) <sup>B)</sup>	0.05-20 m
측정 정확도 <sup>A)</sup>	±1.5 mm
측정 정확도(부적절한 조건) <sup>B)</sup>	±3.0 mm
최소 표시 단위	0.5 mm
<b>일반 사항</b>	
작동 온도 <sup>C)</sup>	-10 °C ... +45 °C
보관 온도	-20 °C ... +70 °C
상대 습도 최대	90 %
기준 높이를 초과한 최대 사용 높이	2000 m
IEC 61010-1에 따른 오염도	2 <sup>D)</sup>
레이저 등급	2
레이저 유형	515 nm, < 1 mW
레이저빔의 편차	< 1.5 mrad(전체 각도)
자동 꺼짐 기능이 활성화되는 대략적인 시간	
- 레이저	20 s
- 측정공구(측정 미포함) <sup>E)</sup>	5 min
<b>간접 거리 측정 및 수준기</b>	
측정 영역	0°-360° (4 × 90°)
<b>경사 측정</b>	
측정 영역	0°-360° (4 × 90°)
측정 정확도 <sup>F)G)</sup>	±0.2°
최소 표시 단위	0.1°
EPTA-Procedure 01:2014에 따른 중량	0.17 kg

<b>디지털 레이저 거리 측정기</b>		<b>GLM 50-27 CG</b>
보호 등급	IP 65 (먼지 및 분무수 침투 방지)	
치수	119 × 53 × 29 mm	
측정 단위 설정	m, ft, in	
배터리	2 × 1.5 V LRR6 (AA)	
<b>배터리팩(액세서리)</b>	<b>리튬 이온</b>	
타입	BA 3.7V 1.0Ah A	
품번	<b>1 607 A35 17H</b>	
USB 충전 단자	Type-C®	
정격 전압	3.7 V ---	
용량	1.0 Ah	
배터리 셀 개수	1	
허용 충전 온도 범위	+10 °C ... +35 °C	
<b>전원 플러그</b>		
출력 전압	5.0 V ---	
최소 출력 전류	500 mA	
<b>데이터 전송</b>		
블루투스®	블루투스® 4.2 (Low Energy) <sup>(H)</sup>	
작동 주파수 범위	2402-2480 MHz	

## 디지털 레이저 거리 측정기

GLM 50-27 CG

최대 송신 출력

8 mW

- A) 측정공구의 앞 모서리부터 측정할 경우, 표적물(예: 흰색으로 칠한 벽)의 반사율을 높게, 배경 조명을 약하게 조성해야 합니다. 작동 온도는 20 °C입니다. 그 외에도 거리에 따라  $\pm 0.05$  mm/m 정도 차이가 있을 수 있음을 고려해야 합니다.
- B) 측정공구의 앞 모서리부터 측정할 경우, 표적물(예: 흰색으로 칠한 벽)의 반사율을 높게, 배경 조명을 강하게 조성해야 합니다. 작동 온도는 20 °C이며, 고도는 높게 설정해야 합니다. 그 외에도 거리에 따라  $\pm 0.15$  mm/m 정도 차이가 있을 수 있음을 고려해야 합니다.
- C) 연속 측정 기능의 경우 최고 작동 온도는 +40 °C입니다.
- D) 비전도성 오염만 발생하지만, 가끔씩 이슬이 맺히면 임시로 전도성이 생기기도 합니다.
- E) 블루투스® 비활성화됨
- F) 작동 온도 25 °C
- G) 0° 및 90°에서 사용자가 캘리브레이션한 후  $\pm 0.01$ /도 ~ 45°(최대) 정도의 경사 오류가 추가로 있을 수 있음을 고려해야 합니다. 측정공구의 좌측은 경사 측정을 위한 기준점 역할을 합니다.
- H) Bluetooth® 저 에너지 기기의 경우, 모델과 작동 시스템에 따라 연결 구성이 불가능할 수 있습니다. Bluetooth® 기기가 GATT 프로필을 지원해야 합니다.

측정공구를 확실하게 구분할 수 있도록 타입 표시판에 일련 번호 (11)가 적혀 있습니다.

## 배터리 삽입하기/교환하기

측정공구 작동에는 알칼리 망간 배터리 또는 니켈 수소 배터리(특히 낮은 작동 온도에서)를 사용할 것을 권장합니다.

1.2 V 충전용 배터리를 사용할 경우 1.5 V 배터리를 사용할 때보다 용량에 따라 측정 가능 횟수가 줄어들 수 있습니다.

» 배터리 케이스 덮개를 여십시오.

» 배터리 또는 충전용 배터리를 삽입합니다.

**i** 항상 배터리나 충전용 배터리는 모두 동시에 교환해 주십시오. 한 제조사의 동일한 용량의 배터리나 충전용 배터리만을 사용하십시오.

**i** 이때 전극이 배터리 케이스 안쪽에 나와있는 것처럼 올바르게 끼워야 합니다.

배터리 또는 충전용 배터리의 충전상태가 낮은 경우 디스플레이에 배터리 절약 모드를 활성화할 것인지 묻는 메시지가 나타납니다. 배터리 절약 모드가 활성화되면 배터리 작동 시간이 늘어나고, 디스플레이에서 배터리 기호에 황

색 테두리가 표시됩니다. (참조 „배터리 절약 모드 켜기/끄기“ , 페이지 122)  
 비어 있는 배터리 기호가 처음 디스플레이에 나타난 경우, 적은 횟수의 측정만 가능합니다.

비어 있는 배터리 기호가 적색으로 깜박이는 경우, 더 이상 측정할 수 없습니다. 배터리나 충전용 배터리 팩을 교체하십시오.

▶ **측정공구를 장기간 사용하지 않을 경우에는 배터리 또는 충전용 배터리를 측정공구에서 분리하십시오.** 장기간 보관할 경우 배터리나 충전용 배터리가 부식되거나 저절로 방전될 수 있습니다.

**i** 측정공구에 배터리 케이스 덮개 (13) 를 또는 리튬 이온 배터리팩 (19) (액세서리)이 삽입되지 않은 상태로 보관하는 일이 절대 없도록 하고, 먼지 혹은 습기가 있는 상태로 보관하지 마십시오.

## 리튬 이온 배터리팩(액세서리)

### 리튬 이온 배터리팩(액세서리) 끼우기/교체하기

- » 리튬 이온 배터리팩 (19) (액세서리)을 끼우십시오.
- » 리튬 이온 배터리팩 (19) (액세서리)을 분리하려면, 잠금쇠 (20) 를 누르고 리튬 이온 배터리팩을 꺼내십시오. (참조 그림 A, 페이지 4)

### 리튬 이온 배터리팩(액세서리) 충전하기

- ▶ **권장하는 USB 전원부 또는 출력 전압 및 최소 출력 전류가 "제품 사양" 단원에 제시된 조건에 부합하는 전원부를 사용하십시오. USB 전원부의 사용 설명서 내용에 유의하십시오.**  
 권장하는 전원부: "제품 사양" 참조.
- ▶ **전원 전압에 유의하십시오!** 공급되는 전원의 전압은 컨넥터 전원부의 명판에 표기된 전압과 동일해야 합니다. 230 V로 표시된 컨넥터 전원부는 220 V에서도 작동이 가능합니다.

**i** 리튬 이온 배터리는 국제 운송 규정에 따라 일부만 충전되어 배송됩니다. 배터리의 성능을 완전하게 보장하기 위해서는 처음 사용하기 전에 배터리를 완전히 충전하십시오.

USB 케이블 (21) 에 연결되는 USB 포트와 충전 표시등은 리튬 이온 배터리팩 (19) (액세서리)의 USB 포트 커버 (22) 아래에 위치해 있습니다.

- » USB 포트의 커버를 제거하십시오 (22).

» USB 케이블 (21) 을 연결하십시오.

충전되는 동안 디스플레이에 나타나는 충전 상태는 실제 리튬 이온 배터리 팩 (19) (액세서리)의 충전 상태와 차이가 있을 수 있습니다.

충전 중에는 충전 표시등이 황색으로 점등됩니다.

리튬 이온 배터리팩 (19) (액세서리)이 완전히 충전되면 충전 표시등이 녹색으로 변합니다.

충전 표시등이 적색으로 점등되면, 충전 전압이나 충전 전류가 올바르지 않은 것입니다.

## 작동

### 기계 시동

- ▶ **축정공구가 켜져 있는 상태에서 자리를 비우지 말고, 사용 후에는 축정공구의 스위치를 끄십시오.** 레이저빔으로 인해 다른 사람의 눈을 일시적으로 안 보이게 할 수 있습니다.
- ▶ **축정공구가 물에 젖거나 직사광선에 노출되지 않도록 하십시오.**
- ▶ **극한의 온도 또는 온도 변화가 심한 환경에 축정공구를 노출시키지 마십시오.** 예를 들어 장시간 차량 안에 축정공구를 두지 마십시오. 온도 변화가 심한 경우 축정공구를 작동시키기 전에 먼저 온도에 적응할 수 있게 하십시오. 극심한 온도에서나 온도 변화가 심한 환경에서 사용하면 축정공구의 정확도가 떨어질 수 있습니다.
- ▶ **축정공구가 외부와 세계 부딪히거나 떨어지지 않도록 주의하십시오.** 축정공구에 외부 영향이 심하게 가해진 후에는 계속 작업하기 전에 항상 정확도 점검 (참조 “정확도 점검”, 페이지 137) 을 해야 합니다.

### 전원 켜기/끄기

» 버튼 ▲을 누르면, 축정공구 및 레이저의 전원이 켜집니다.

버튼 ⏻을 누르면, 레이저를 켜지 않은 채로 축정공구의 전원을 켤 수 있습니다.



» 버튼 ⏻을 계속 누르고 있으면, 축정공구의 전원이 꺼집니다.

메모리에 저장된 값들과 장치 설정은 그대로 유지됩니다.

### 축정 과정

전원을 처음 켜면 축정공구는 길이 측정 기능에 위치합니다. 다시 전원을 켤 때마다 축정공구는 마지막으로 사용한 측정 기능에 있습니다.

측정 기준 레벨의 경우 세 가지 설정이 제공됩니다. (참조 „측정 기준점 선택하기“, 페이지 120)

- » 측정공구를 원하는 측정 시작점(예: 벽)에 두십시오.
- » 버튼  을 눌러 측정공구의 전원을 켜 후, 버튼  을 짧게 눌러 레이저를 켜십시오.
- » 측정을 진행하려면, 버튼  을 누르십시오.

측정을 진행한 후에는 레이저빔이 꺼집니다. 다시 측정하려면 상기 과정을 반복하십시오.

측정값 또는 최종 결과는 더하거나 뺄 수 있습니다.

측정값은 타입별로 0.5 초 내에, 늦어도 4 초 정도 후에 디스플레이됩니다.

측정 시간은 거리, 조명 상태 그리고 표적면의 반사 정도에 따라 좌우됩니다.

측정을 진행한 후에는 레이저빔이 자동으로 꺼집니다.

 측정하는 동안 본 측정공구를 움직여서는 안 됩니다(단, 연속 측정 기능과 경사 측정 기능 제외). 따라서 측정공구는 최대한 단단한 고정면 또는 설치면에 올려 두십시오.

 측정 시 수신 렌즈 (15) 및 레이저빔 발사구 (16) 가 가려지지 않도록 하십시오.

### 측정 영역에 미치는 영향

측정 영역은 조명 상태 그리고 표적면의 반사 정도에 따라 달라집니다.

외부 라이트가 강렬할 때 레이저빔의 가시성을 높이려면, 레이저용 안경 (27) (액세서리) 및 레이저 표적판 (26) (액세서리)을 사용하거나 또는 표적면을 어둡게 만드십시오.

### 측정 결과에 미치는 영향

물리적 효과로 인해 서로 다른 표면에서 측정 시 측정 오류가 발생할 수도 있습니다. 예:



- 투명한 표면(예: 유리, 물),
- 반사 표면(예: 광택 처리된 금속, 유리),
- 다공질 표면(예: 방음재),
- 구조화된 표면(예: 초벽칠, 자연석).

이러한 표면에서는 필요에 따라 레이저 표적판 (26) (액세서리)을 사용하십시오.

그 외 비스듬하게 조준된 표적면에서도 측정 오류가 발생할 수 있습니다.

온도가 서로 다른 공기층 또는 간접적으로 수신된 반사로 인해서도 측정값이 영향을 받을 수 있습니다.

## 메뉴 탐색

메뉴에서 버튼  을 눌러 우측으로 이동하거나 버튼  을 눌러 좌측으로 이동할 수 있습니다.

선택한 사항을 승인하려면, 버튼  또는 버튼  을 누르십시오.

메뉴 화면에서 벗어나려면, 버튼  을 누르십시오.

## 측정 기준점 선택하기

측정할 경우 다양한 측정 기준점 중에 선택할 수 있습니다:



측정공구의 뒷 모서리(예: 벽면에 설치할 경우)





삼각대 나사부 (14) 의 중간(예: 삼각대를 이용하여 측정할 경우)



측정공구의 앞 모서리(예: 책상 가장자리에서부터 측정할 경우)

» 버튼  을 누르면, **기본 설정** 메뉴가 열립니다.

»  을 선택하십시오.

» 버튼  또는 버튼  을 눌러 원하는 기준 레벨을 선택하십시오.



» 선택한 사항을 승인하려면, 버튼  을 누르십시오.

측정공구의 전원을 켜면 항상 마지막으로 선택한 기준 레벨로 사전 설정되어 있습니다.









이미 측정이 끝난 값(예: 측정값 목록에 나타나는 측정값)의 기준 레벨을 나중에 변경하는 것은 불가능합니다.

## 기본 설정 메뉴



기본 설정 메뉴에서 다음과 같은 기본 설정을 확인할 수 있습니다:

-  측정 기준점 변경하기 (참조 „측정 기준점 선택하기“, 페이지 120)
-  음향 신호 켜기/끄기



-  진동 켜기/끄기
-  디스플레이 밝기 설정
-  배터리 절약 모드 켜기/끄기
-  단위 변경하기
-  언어 설정
-  경사 측정 캘리브레이션 (참조 „정확도 점검“, 페이지 137)
-  장치 정보 불러오기
-  초기 설정
-  모든 이미지 삭제

» 버튼  을 누르면, **기본 설정** 메뉴가 열립니다.

» 버튼  또는 버튼  을 눌러 원하는 설정을 선택하십시오.

» 선택한 사항을 승인하려면, 버튼  또는 버튼  을 누르십시오.



» **기본 설정** 메뉴를 닫으려면, 버튼  을 짧게 누르십시오.

### 음향 신호 켜기/끄기

기본 설정에는 음향이 켜져 있습니다.

» 버튼  을 누르면, **기본 설정** 메뉴  가 열립니다.

»  을 선택하십시오.

» 버튼  또는 버튼  을 누르면 선택한 사항을 변경할 수 있습니다.

» 선택한 사항을 변경하려면, 버튼  또는 버튼  을 누르십시오.









» **기본 설정** 메뉴  를 닫으려면, 버튼  을 짧게 누르십시오.

측정공구를 끄면 선택한 설정은 그대로 저장됩니다.

### 진동 켜기/끄기









기본 설정에는 진동이 켜져 있습니다.

측정공구의 진동은 시끄러운 환경 등에서 유용하게 사용할 수 있습니다. 짧게 두 번 진동하면 측정이 성공적으로 완료되었음을 알리고, 한 번 길게 진동하면 측정에 오류가 있음을 알립니다.

- » 버튼  을 누르면, **기본 설정** 메뉴  가 열립니다.
- »  을 선택하십시오.
- » 버튼  또는 버튼  을 누르면 선택한 사항을 변경할 수 있습니다.
- » 선택한 사항을 변경하려면, 버튼  또는 버튼  을 누르십시오.
- » **기본 설정** 메뉴  를 닫으려면, 버튼  을 짧게 누르십시오.  
축정공구를 끄면 선택한 설정은 그대로 저장됩니다.









### 디스플레이 밝기 설정

디스플레이 밝기는 주변 조건에 맞춰 여러 단계로 조정할 수 있습니다.

- » 버튼  을 누르면, **기본 설정** 메뉴  가 열립니다.
- »  을 선택하십시오.
- » 버튼  또는 버튼  을 누르면 선택한 사항을 변경할 수 있습니다.
- » 선택한 사항을 변경하려면, 버튼  또는 버튼  을 누르십시오.
- » **기본 설정** 메뉴  를 닫으려면, 버튼  을 짧게 누르십시오.  
축정공구를 끄면 선택한 설정은 그대로 저장됩니다.











### 배터리 절약 모드 켜기/끄기

기본 설정에는 배터리 절약 모드가 꺼져 있습니다. 배터리 절약 모드가 켜진 경우 음향과 진동이 비활성화되고, 디스플레이의 밝기가 어두워집니다. 이로 인해 배터리 작동 시간이 늘어납니다.

- » 버튼  을 누르면, **기본 설정** 메뉴  가 열립니다.
- »  을 선택하십시오.
- » 버튼  또는 버튼  을 누르면 선택한 사항을 변경할 수 있습니다.
- » 선택한 사항을 변경하려면, 버튼  또는 버튼  을 누르십시오.
- » **기본 설정** 메뉴  를 닫으려면, 버튼  을 짧게 누르십시오.  
축정공구를 끄면 선택한 설정은 그대로 저장됩니다.

## 단위 변경하기











기본 설정의 측정 단위는 "m"(미터)입니다. 6개의 다양한 단위가 제공됩니다. 목적에 맞는 단위를 설정하십시오.

- » 버튼  을 누르면, **기본 설정** 메뉴  가 열립니다.
- »  을 선택하십시오.
- » 버튼  또는 버튼  을 누르면 선택한 사항을 변경할 수 있습니다.
- » 선택한 사항을 변경하려면, 버튼  또는 버튼  을 누르십시오.
- » **기본 설정** 메뉴  를 닫으려면, 버튼  을 짧게 누르십시오.  측정공구를 끄면 선택한 설정은 그대로 저장됩니다.

## 언어 설정





측정공구의 전원을 처음 켜면 디스플레이 사용 시 선호하는 언어를 설정하도록 요구합니다.



설정된 언어는 언제든지 변경할 수 있습니다.

- » 버튼  을 누르면, **기본 설정** 메뉴  가 열립니다.
- » 기타 사항을 설정하려면  을 선택하십시오.
- »  을 선택하십시오.
- » 버튼  또는 버튼  을 누르면 선택한 사항을 변경할 수 있습니다.
- » 선택한 사항을 변경하려면, 버튼  또는 버튼  을 누르십시오.
- » **기본 설정** 메뉴  를 닫으려면, 버튼  을 짧게 누르십시오.  측정공구를 끄면 선택한 설정은 그대로 저장됩니다.

## 장치 정보

여기에서는 일련 번호, 소프트웨어 버전 및 라이선스와 같은 측정공구 관련 정보를 확인할 수 있습니다.

- » 버튼  을 누르면, **기본 설정** 메뉴  가 열립니다.
- » 기타 사항을 설정하려면  을 선택하십시오.
- »  을 선택하십시오.

» **기본 설정** 메뉴 를 닫으려면, 버튼 을 짧게 누르십시오.



### 초기 설정



이 기능은 측정공구를 초기 설정/기본 설정으로 리셋하는 역할을 합니다. 리셋하면 디스플레이 사용 시 선호하는 언어를 설정하도록 요구합니다.

» 버튼 을 누르면, **기본 설정**  메뉴가 열립니다.

» 기타 사항을 설정하려면 **...**을 선택하십시오.

» 을 선택하십시오.

» 측정공구를 리셋하려면 을 선택하고 버튼 나 버튼 을 눌러 승인하십시오.





» **기본 설정** 메뉴 를 닫으려면, 버튼 을 짧게 누르십시오.

### 모든 이미지 삭제

» 버튼 을 누르면, **기본 설정** 메뉴 가 열립니다.

» 기타 사항을 설정하려면 **...**을 선택하십시오.





» 을 선택하십시오.

» 이미지를 삭제하려면, 버튼  또는 버튼 을 눌러 을 선택하고, 버튼  또는 버튼 을 눌러 승인하십시오.  
모든 측정값이 삭제됩니다.

## 측정 기능

### 측정 기능 선택하기/변경하기

기능 메뉴에서 다음과 같은 기능을 확인할 수 있습니다:

-  길이 측정
-  연속 측정
-  면적 측정
-  체적 측정
-  간접 거리 측정

- 간접 높이 측정
- 이중 간접 높이 측정
- 간접 길이 측정
- □ 벽 면적 측정
- ≡ 분리 기능
- ≡ 경사 측정/디지털 수준기
- ≡ 메모리 기능

» 버튼 **Func**을 누르면, **기능** 메뉴가 열립니다.

» 버튼 **▶** 또는 버튼 **◀**을 눌러 원하는 측정 기능을 선택하십시오.

» 선택한 사항을 변경하려면, 버튼 **Func** 또는 버튼 **▲**을 누르십시오.

### 내장된 도움말 기능 ?

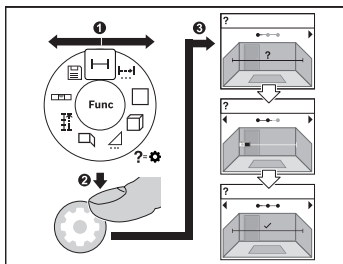

측정공구에 내장된 도움말 기능은 모든 측정 기능/측정 과정에 대한 동영상상을 제공합니다.

» **기능** 메뉴를 여십시오.

» 버튼 **▶** 또는 버튼 **◀**을 눌러 원하는 기능을 선택한 후 버튼 **⚙**을 누르십시오.

동영상은 선택한 측정 기능에 대한 세부적인 작업 절차를 알려줍니다.

» 버튼 **▶** 또는 **◀**를 누르면, 다음 단계 또는 이전 단계가 표시됩니다.

### 길이 측정 —

» 버튼 **Func**을 누르면, **기능** 메뉴가 열립니다.

» 길이 측정 **—**을 선택한 후 버튼 **Func**을 눌러 선택한 사항을 승인하십시오.

» 버튼 **▲**을 짧게 누르면, 레이저의 전원이 켜집니다.

» 측정을 진행하려면, 버튼 **▲**을 누르십시오.

디스플레이 하단 결과 표시열 (e) 에 측정값이 표시됩니다.

» 다시 측정할 때마다 상기 제시된 과정을 반복하십시오.

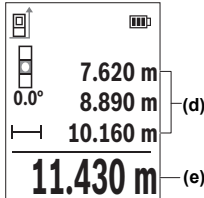

길이 측정이 여러 번 연이어 진행된 경우 결과 표시열 (d) 에 마지막 측정 결과가 표시됩니다. 마지막 측정값이 디스플레이 하단에, 마지막에서 두 번째 측정값이 그 위에 차례로 표시됩니다.

### 면적 측정

» 버튼 **Func** 을 누르면, **기능** 메뉴가 열립니다.

» 면적 측정  을 선택한 후 버튼 **Func** 을 눌러 선택한 사항을 승인하십시오.

» 버튼 **▲** 을 짧게 누르면, 레이저의 전원이 켜집니다.

» 버튼 **▲** 을 누르면, 공간의 길이 등 첫 번째 측정이 진행됩니다.

» 버튼 **▲** 을 누르면, 공간의 너비 등 두 번째 측정이 진행됩니다.

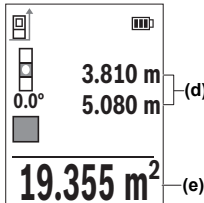

두 번째 측정을 하고 나면 면적이 자동으로 계산되어 표시됩니다. 결과 표시열 (e) 에 결과가 표시됩니다. 개별 측정값이 결과 표시열 (d) 에 표시됩니다.

### 연속 측정

연속 측정 시에는 측정값이 계속해서 업데이트됩니다. 예를 들어 벽면에서 현하는 간격까지 움직일 수 있으며, 현재 거리는 항상 판독 가능합니다.

연속 측정을 위한 세 가지 기능이 있는데, 각각의 측정값은 디스플레이에 다르게 표시됩니다:

**최소/최대** <sup>min</sup>  
<sub>max</sub>

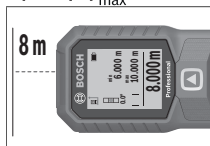

최소 측정값과 최대 측정값은 항상 디스플레이에 표시됩니다.

- » 버튼 **Func**을 누르면, **기능** 메뉴가 열립니다.
- » 연속 측정 메뉴 항목 **1-3**에서 최소/최대 <sup>min</sup><sub>max</sub>를 선택한 후 버튼 **Func**을 눌러 선택한 사항을 승인하십시오.

오.

- » 버튼 **▲**을 짧게 누르면, 레이저의 전원이 켜집니다.
- » 결과 표시열에 원하는 거리값이 표시될 때까지 측정공구를 계속 움직입니다.
- » 버튼 **▲**을 짧게 눌러 연속 측정을 중단할 수 있습니다.
- » 버튼 **▲**을 다시 누르면, 연속 측정을 계속해서 진행할 수 있습니다.

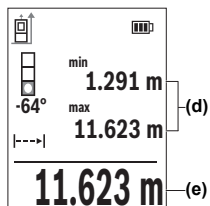

현재 측정값이 결과 표시열 **(e)**에 표시되고, **±**치대 및 최소 측정값은 측정값 표시열 **(d)**에 표시됩니다.

**숫자 확대** <sup>o0</sup>

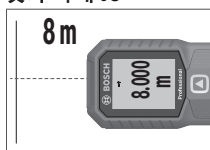

가독성을 높이기 위해 측정값이 확대되어 표시됩니다.

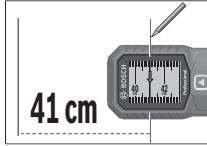
줄자 

거리가 줄자 모양으로 표시됩니다.

**i** 줄자 기능에서 측정 기준점은 디스플레이에 표시된 마크에 해당됩니다. 측정공구의 모서리는 측정 기준점이 아닙니다.

4 분이 지나면 자동으로 연속 측정이 꺼집니다.

체적 측정 

- » 버튼 **Func**을 누르면, **기능** 메뉴가 열립니다.
- » 체적 측정 을 선택한 후 버튼 **Func**을 눌러 선택한 사항을 승인하십시오.
- » 버튼 **▲**을 짧게 누르면, 레이저의 전원이 켜집니다.
- » 버튼 **▲**을 누르면, 공간의 길이 등 첫 번째 측정이 진행됩니다.
- » 버튼 **▲**을 누르면, 공간의 너비 등 두 번째 측정이 진행됩니다.
- » 버튼 **▲**을 누르면, 공간의 높이 등 세 번째 측정이 진행됩니다.

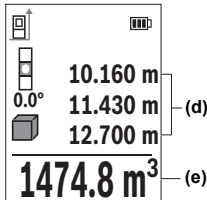

세번째 측정을 하고 나면 체적이 자동으로 계산되어 표시됩니다. 결과 표시열 **(e)**에 결과가 표시됩니다. 개별 측정값이 측정값 표시열 **(d)**에 표시됩니다.

간접 거리 측정 

간접 거리 측정 기능은 장애물이 있어 레이저빔 측정이 불가능하거나 표적면을 반사체로 이용할 수 없어 거리를 직접 측정할 수 없을 경우 사용할 수 있습니다. 이 측정방법은 수직 방향으로만 사용할 수 있습니다. 수평 방향으로 사용하면 측정 오류가 발생할 수 있습니다.





간접 거리 측정은 항상 직접 거리 측정보다 정확도가 떨어집니다. 측정 오류는 사용에 따라 직접 거리 측정 시보다 점점 더 커집니다. 측정 정확도를 높이기 위해 삼각대(액세서리)를 사용하면 좋습니다.

① 삼각대를 사용하는 경우 설정한 측정 기준점에 유의하십시오. (참조 „측정 기준점 선택하기“, 페이지 120)

개별 측정을 하는 동안 레이저빔은 켜져 있습니다.

간접 거리 측정의 경우 각각 다양한 구간을 측정할 수 있는 3 가지 측정 기능이 있습니다.





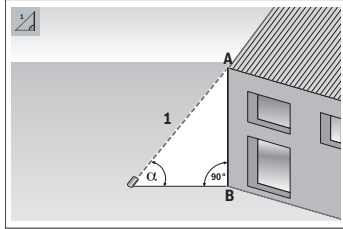

-  간접 높이 측정
-  이중 간접 높이 측정
-  간접 길이 측정

#### 간접 높이 측정



간접 높이 측정 기능을 이용해 구간 1을 측정하여 구간 AB를 산출할 수 있습니다. 측정공구는 각도  $\alpha$  및 구간 1로부터 구하고자 하는 높이 AB를 계산합니다.

개별 측정 시 요구되는 직각이 정확하게 유지되는 경우에만 정확한 결과가 도출됩니다.



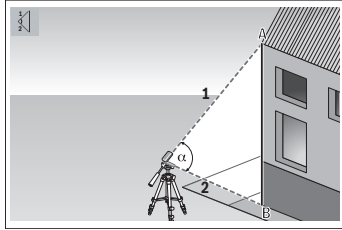

- » 버튼  을 누르면, 기능 메뉴가 열립니다.
- » 간접 거리 측정  을 선택한 후 버튼  을 눌러 선택한 사항을 승인하십시오.
- » 간접 높이 측정  을 선택한 후 버튼  을 눌러 선택한 사항을 승인하십시오.
- » 버튼  을 짧게 누르면, 레이저의 전원이 켜집니다.
- » 측정공구를 아래 측정점 B의 높이에 맞춰 세우십시오.
- » 레이저가 위 측정점 A에 맞춰 정렬될 수 있도록 측정공구를 기울이십시오.
- » 측정을 진행하려면, 버튼  을 누르십시오.

측정을 하고 나면 높이가 자동으로 계산되어 결과 표시열 (e) 에 표시됩니다.  
구간 1에 대한 측정값 및 각도  $\alpha$ 는 측정값 표시열 (d) 에 표시됩니다.

### 이중 간접 높이 측정





이중 간접 높이 측정 기능을 이용해 구간 1 및 2를 측정하여 구간 AB를 산출할 수 있습니다. 본 측정공구는 각도  $\alpha$  및 구간 1 및 2로부터 구하고자 하는 높이 AB를 계산합니다.  
본 측정 진행 시 삼각대 사용을 권장합니다.

- » 버튼 **Func**을 누르면, **기능** 메뉴가 열립니다.
- » 간접 거리 측정 을 선택한 후 버튼 **Func**을 눌러 선택한 사항을 승인하십시오.
- » 이중 간접 높이 측정 을 선택한 후 버튼 **Func**을 눌러 선택한 사항을 승인하십시오.
- » 버튼 을 짧게 누르면, 레이저가 켜집니다.
- » 레이저가 위 측정점 A에 맞춰 정렬될 수 있도록 측정공구를 기울이십시오.
- » 첫 번째 측정을 진행하려면, 버튼 을 누르십시오.
- » 레이저가 아래 측정점 B에 맞춰 정렬될 수 있도록 측정공구를 기울이십시오. 이때 측정공구의 위치를 변경하지 마십시오.
- » 버튼 을 누르면, 두 번째 측정이 진행됩니다.

측정을 하고 나면 높이가 자동으로 계산되어 결과 표시열 (e) 에 표시됩니다.  
구간 1, 2 및 각도  $\alpha$ 에 대한 측정값이 측정값 표시열 (d) 에 표시됩니다.

### 간접 길이 측정

- » 버튼 **Func**을 누르면, **기능** 메뉴가 열립니다.
- » 간접 거리 측정 을 선택한 후 버튼 **Func**을 눌러 선택한 사항을 승인하십시오.

- » 간접 길이 측정  을 선택한 후 버튼 **Func** 을 눌러 선택한 사항을 승인하십시오.
- » 측정공구를 구하고자 하는 구간 **AB**의 시작점 **A**에 올려 두십시오.
- » 레이저가 종로점 **B**가 있는 레벨에 맞춰 정렬될 수 있도록 측정공구를 기울어 주십시오.
- » 측정을 진행하려면, 버튼  을 누르십시오.

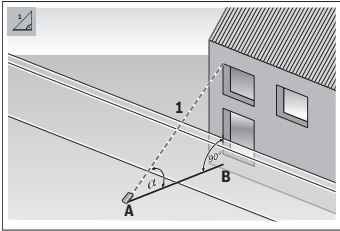

간접 길이 측정 기능을 이용해 구간 **1**을 측정하여 구간 **AB**를 산출할 수 있습니다. 측정공구는 각도  $\alpha$  및 구간 **1**로부터 구하고자 하는 길이 **AB**를 계산합니다.

측정을 하고 나면 길이가 자동으로 계산되어 결과 표시열 **(e)**에 표시됩니다. 구간 **1**에 대한 측정값 및 각도  $\alpha$ 는 측정값 표시열 **(d)**에 표시됩니다.

### 벽 면적 측정

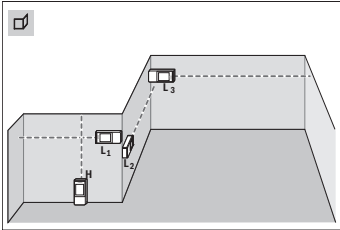

벽 면적 측정은 높이가 동일한 여러 단면적의 합한 값을 구하는데 사용할 수 있습니다. 정확하게 면적을 산출하려면 첫 번째로 측정한 길이(예시에서는 공간 높이 **H**)가 모든 측정 부분에서 동일해야 합니다. 제시된 예시에서는 공간의 높이 **H**는 같지만, 길이 **L**이 서로 다른 여러 벽의 전체 면적을 산출해야 합니다.

- » 버튼 **Func** 을 누르면, **기능** 메뉴가 열립니다.
  - » 벽 면적 측정  을 선택한 후 버튼 **Func** 을 눌러 선택한 사항을 승인하십시오.
  - » 길이 측정할 때와 같이 공간 높이 **H**를 측정하십시오.
- 상단 측정값행에 해당 측정값이 표시됩니다. 레이저는 켜진 상태입니다.

» 그리고 나서 첫 번째 벽의 길이 **L1**를 측정하십시오.

면적이 자동으로 계산되어 결과 표시열에 표시됩니다. 마지막 길이 측정값은 하단 측정값 표시열에 표시됩니다. 레이저는 켜진 상태입니다.

» 이제 두 번째 벽의 길이 **L2**를 측정하십시오.

임의로 여러 개의 다른 길이 **LX**를 측정할 수 있으며, 측정된 값은 자동으로 합산되고 높이 **H**와 곱하여 계산됩니다.

측정값 표시열 (**d**) 에 표시된 개별 측정값은 길이 **L1** 에 합산됩니다. 두 길이를 합한 값(중간 측정값 표시열 (**d**) 에 표시)에 저장된 높이 **H**가 곱해집니다. 전체 면적값은 디스플레이 하단 결과 표시열 (**e**) 에 측정값이 표시됩니다.

### 분리 기능

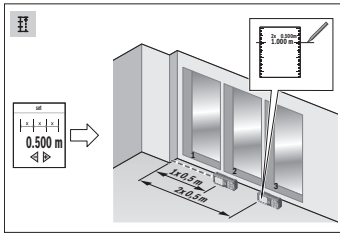

 분리 기능에서 측정 기준점은 디스플레이에 표시된 마크에 해당됩니다. 측정공구의 모서리는 측정 기준점이 아닙니다.



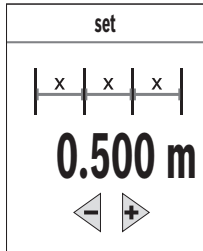

분리 기능을 통해 반복하여 정해진 길이(구간)를 측정합니다. 한 표면에서 정해진 길이 전송이 가능하며, 작업 소재를 동일한 길이로 절단하거나 건식 벽에 스톱트 월을 설치할 때 등에 활용할 수 있습니다. 설정 가능한 최소 길이는 0.1 m이며, 최대 길이는 50 m입니다.



» 버튼  을 누르면, 기능 메뉴가 열립니다.

» 분리 기능  을 선택한 후 버튼  을 눌러 선택한 사항을 승인하십시오.

» 버튼  또는 버튼  을 눌러 원하는 길이를 설정하십시오.

버튼  또는 버튼  을 누르고 있으면, 해당 길이를 큰 범위의 단계별로 변경할 수 있습니다.

» 버튼  을 누르면, 분리 기능이 시작됩니다. 시작점으로부터 서서히 벗어나십시오.

측정공구는 계속해서 시작점과의 간격을 측정합니다. 이때 정의된 길이 및 현재 측정값이 표시됩니다. 하단 또는 상단의 화살표는 다음 표시 또는 이전 표시와의 최소 거리 간격을 표시합니다.

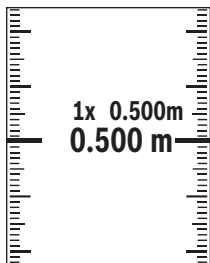

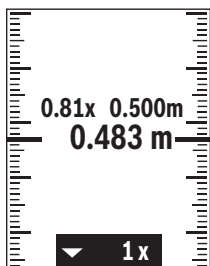

좌측의 계수는 정의된 길이에 얼마나 도달했는지 알려줍니다. 디스플레이 측면의 녹색 라인은 길이에 도달했음을 표시하기 위한 목적으로 표시됩니다.



기준값이 디스플레이 영역을 벗어난 경우, 청색 라인 및 청색 문자 표시가 실제값을 나타냅니다.

### 경사 측정/디지털 수준기

디지털 수준기는 (예를 들어 세탁기, 냉장고 등) 물체의 수평 또는 수직 방향을 점검하는 데 사용됩니다. 경사 측정은 (예를 들어 계단, 난간, 가구를 들어올 때, 파이프를 배선할 때 등) 경사 또는 기울기를 측정하는 데 사용됩니다. 측정공구는 측정공구의 위치를 바꾸면 두 가지 기능 사이에서 자동으로 전환됩니다.

- » 버튼  을 누르면, 기능 메뉴가 열립니다.
- » 경사 측정/디지털 수준기  를 선택한 후 버튼  을 눌러 선택한 사항을 승인하십시오.

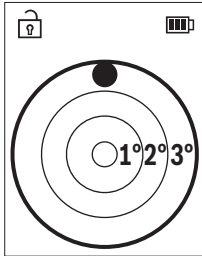

측정공구의 아래쪽은 디지털 수준기를 위한 측정 기준점 역할을 합니다.

» 디지털 수준기를 이용하려면, 측정공구의 뒷면이 측정해야 할 표면을 향하도록 두십시오.

버튼 ▲을 짧게 눌러 측정값이 바뀌지 않도록 설정할 수 있습니다.

» 경사가 3°를 초과하면, 디스플레이의 구가 적색으로 점등됩니다.

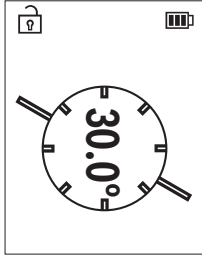

측정공구의 좌측은 경사 측정을 위한 기준점 역할을 합니다. 측정 과정 중에 표시기가 깜박이면, 측정공구가 지나치게 옆으로 기울어졌기 때문입니다.

» 경사 측정을 이용하려면, 측정공구의 측면이 경사를 측정할 물체를 향하도록 두십시오.

버튼 ▲을 눌러 측정값이 바뀌지 않도록 설정할 수 있습니다.



## 메모리 기능

측정이 종료될 때마다 해당 값 또는 최종 결과는 자동으로 저장됩니다. 마지막 30 개의 값(측정값 또는 최종 결과)이 저장됩니다. 메모리가 꽉 차면, 가장 오래된 값이 덮어쓰기 됩니다. (제공되는 30 개의 메모리 값 중에서) 가장 오래된 값은 메모리의 위치 1에, 마지막 값은 위치 30 에 위치합니다.

» 버튼 을 누르면, 기능 메뉴가 열립니다.

» 메모리 기능 을 선택한 후 버튼 을 눌러 선택한 사항을 승인하십시오.

마지막 값이 표시됩니다.

» 버튼  또는 버튼 을 누르면, 저장된 값을 넘겨볼 수 있습니다.

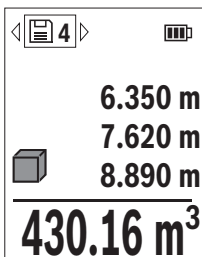

디스플레이 상단에 메모리 값의 번호가 표시되고, 좌측에는 해당 측정 기능의 아이콘이 표시됩니다. 메모리에 저장된 값이 없으면, 디스플레이 하단에 "0.000" 및 상단에 "0"이 표시됩니다.

### 메모리 값 삭제하기

» 표시된 값을 삭제하려면, 버튼 을 누르십시오.

» 버튼 을 눌러 승인하십시오.

저장된 모든 값을 삭제하려면, **기본 설정** 메뉴 에서 메뉴항목 **메모리 삭제** 를 선택하십시오. (참조 „모든 이미지 삭제 “, 페이지 124)

### 값 더하기/빼기

#### 길이 측정 시 값 더하기

» 길이 측정 기능을 선택하십시오.

» 첫 번째 측정을 진행하십시오.

» 버튼 을 누르십시오.

» 두 번째 측정을 진행하십시오.

두 번째 측정이 완료되면, 두 번째 측정의 결과가 측정값 표시열 (d) 에 표시되고 최종 결과가 결과 표시열 (e) 에 표시됩니다.

#### 면적 및 체적 측정 시 값 더하기

» 면적 측정 또는 체적 측정 기능을 선택하십시오.

» 첫 번째 면적 측정 또는 체적 측정을 진행하십시오.

» 버튼 을 누르십시오.

» 두 번째 면적 측정 또는 체적 측정을 진행하십시오.

두 번째 또는 세 번째 측정을 하고 나면 면적 또는 체적이 자동으로 계산되어 표시됩니다. 결과 표시열 (e) 에 결과가 표시됩니다. 개별 측정값이 측정값 표시열 (d) 에 표시됩니다.

» 버튼 ▲ 을 누르면, 최종 합산 결과가 표시됩니다.

결과 표시열 (e) 에 최종 결과가 표시됩니다. 개별 면적 측정 또는 체적 측정 결과가 측정값 표시열 (d) 에 표시됩니다.

## 값 빼기

» 값을 빼려면 버튼 ◀ 을 누르십시오. 다른 작업 절차는 "값 더하기"와 동일하게 진행됩니다.

## 측정값 삭제하기

모든 측정 기능에서 버튼 Ⓞ 을 짧게 눌러 마지막으로 산출된 측정값을 삭제할 수 있습니다.

버튼 Ⓞ 을 여러 차례 짧게 누르면 측정값들이 역순으로 삭제됩니다.

## 블루투스® 인터페이스

### 다른 기기로의 데이터 전송

본 측정공구에는 블루투스® 모듈이 장착되어 있으며, 이 모듈은 무선 기술을 이용하여 블루투스® 인터페이스가 있는 특정한 모바일 단말기에 데이터를 전송합니다(예: 스마트폰, 태블릿).

블루투스® 연결에 필요한 시스템 전제조건에 관한 정보는 보쉬 인터넷 사이트 [www.bosch-pt.com](http://www.bosch-pt.com)에서 확인할 수 있습니다.

▶ 보다 상세한 정보는 보쉬 제품 사이트에서 확인할 수 있습니다.

블루투스® 를 이용하여 데이터를 전송할 경우 모바일 단말기와 측정공구 간에 시간 지연이 있을 수 있습니다. 이는 두 기기 간의 거리 때문일 수도 있고, 측정 대상 자체에 원인이 있을 수도 있습니다.

### 모바일 단말기로 데이터를 전송하기 위해 블루투스® 인터페이스 활성화

✓ 모바일 단말기에 있는 블루투스® 인터페이스가 활성화되었는지 확인하십시오.

» 버튼 ✱ 을 누르면, 블루투스® 메뉴가 열립니다.



» 블루투스® 인터페이스를 활성화하려면 버튼  을 다시 누르십시오.

(b) 연결 상태 및 활성화된 연결 (b) 은 측정공구의 상태  
바 (h) 에 표시됩니다.

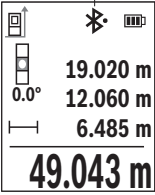
(h)  기능을 추가할 수 있도록 보쉬 앱이 제공됩니다. 단말  
기에 따라 해당 앱 스토어에서 다운받으실 수 있습니  
다.  
보쉬 애플리케이션을 시작하면 모바일 단말기와 측  
정공구가 연결됩니다. 활성화된 여러 개의 측정공구  
중에 일련 번호에 따라 적합한 것을 고르십시오. 일련  
번호 (11) 는 측정공구의 타입 표시판에 적혀 있습니  
다.

### 블루투스® 인터페이스 비활성화

» 블루투스® 메뉴를 열려면 버튼  을 누르시고, 블루투스® 인터페이스를  
비활성화하려면 버튼  을 다시 누르십시오.

### 정확도 점검

경사 측정 및 거리 측정의 정확도를 정기적으로 점검하십시오.

#### 정확도 점검 및 경사 측정 캘리브레이션

» 우선 측정공구를 책상 위에 놓고 그 경사를 측정합니다.

» 측정공구를 180° 돌린 후 다시 경사를 측정합니다.

표시된 숫자의 편차가 최대 0.3° 이하여야 합니다.

편차가 클 경우 측정공구를 새로 캘리브레이션해야 합니다.

» 버튼  을 누르면, 기본 설정 메뉴가 열립니다.

»  을 선택한 후 버튼  을 눌러 선택한 사항을 승인하십시오.

» 디스플레이에 나온 지침을 따르십시오.

 심한 온도 변화를 겪었거나 충격을 받은 경우, 측정공구의 정확도를 점  
검해 본 후 필요에 따라 캘리브레이션하기를 권장합니다. 온도 변화 후  
측정공구를 캘리브레이션하기 전에, 일정 시간동안 측정공구가 온도에 적응  
할 수 있도록 해야 합니다.

### 거리 측정 정확도 점검

정확도 점검을 위해 적절한 조건에서 측정을 진행해야 합니다. 즉, 측정 구간은 실내에 위치해야 하며, 측정하는 표적면은 매끄럽고 반사율이 높아야 합니다(예: 흰색으로 칠한 벽).

- » 그 길이가 정확하게 알려진 약 **3~ 10 m** 사이의 측정 구간을 선택하십시오(예: 공간 너비, 문 입구).
- » 해당 구간을 10회 연속으로 측정하십시오.

적절한 조건에서 개별 측정 시 정확하게 알려진 치수와의 편차가 전체 측정 구간에서 최대  $\pm 2$  mm를 넘어서는 안 됩니다. 차후에 정확도를 비교할 수 있도록, 측정된 값을 기록하십시오.

### 삼각대(액세서리)를 이용해 작업하기

특히 먼거리를 측정할 때 삼각대를 사용하면 도움이 됩니다.

- » 1/4" 나사부 (14) 와 함께 측정공구를 삼각대 (25) 의 순간 교환 플레이트 혹은 일반 카메라 삼각대 위에 놓습니다.
- » 그리고 나서 측정공구를 순간 교환 플레이트의 고정 나사로 조이면 됩니다.
- » 측정을 위한 기준점을 설정하십시오 (참조 „측정 기준점 선택하기“, 페이지 120).

## 벨트 클립

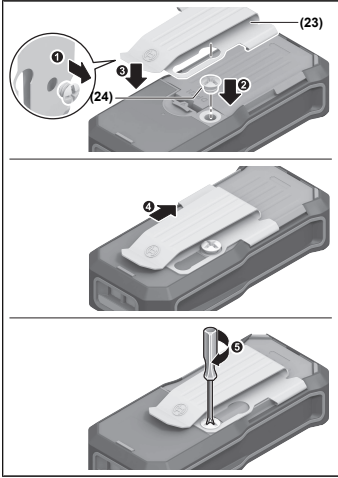

벨트 클립 (23) 을 이용해 측정공구를 벨트에 걸어 편리하게 사용할 수 있습니다.

벨트 클립을 측정공구에 장착하려면, 그림에 제시된 순서를 따르십시오.

## 오류 메시지

측정을 정확하게 실행할 수 없는 경우, 디스플레이에 오류 메시지 **Error**가 표시됩니다.

- » 측정 과정을 다시 한번 시도하십시오.
- » 오류 메시지가 다시 나타나는 경우, 측정공구의 전원을 껐다가 다시 켜 후 측정을 새로 시작하십시오.



본 측정공구는 측정할 때마다 제대로 작동하는지 감시합니다. 결함이 확인되면, 디스플레이에 옆에 표시된 기호가 표시되고, 측정공구가 저절로 꺼집니다. 이 경우, 담당 딜러를 통해 측정공구를 보수 서비스 센터에 맡기십시오.

## 보수 정비 및 서비스

### 보수 정비 및 유지

반드시 측정공구를 함께 공급된 안전 케이스에 넣어 보관하고 운반하십시오.  
항상 측정공구를 깨끗이 유지하십시오.

측정공구를 물이나 다른 액체에 넣지 마십시오.

물기있는 부드러운 천으로 오염된 부위를 깨끗이 닦으십시오. 세척제 또는 용제를 사용하지 마십시오.

특히 수신 렌즈 (15) 는 안경이나 카메라 렌즈를 다루듯이 조심스럽게 관리하십시오.

수리하는 경우 측정공구를 안전 케이스 (18) 에 넣어 보내주십시오.

### AS 센터 및 사용 문의

AS 센터에서는 귀하 제품의 수리 및 보수정비, 그리고 부품에 관한 문의를 받고 있습니다. 대체 부품에 관한 분해 조립도 및 정보는 인터넷에서도 찾아 볼 수 있습니다 - [www.bosch-pt.com](http://www.bosch-pt.com)

보쉬 사용 문의 팀에서는 보쉬의 제품 및 해당 액세서리에 관한 질문에 기꺼이 답변 드릴 것입니다.

문의나 대체 부품 주문 시에는 반드시 제품 네임 플레이트에 있는 10자리의 부품번호를 알려 주십시오.

콜센터  
080-955-0909

**다른 AS 센터 주소는 아래 사이트에서 확인할 수 있습니다:**

[www.bosch-pt.com/serviceaddresses](http://www.bosch-pt.com/serviceaddresses)

### 운반

권장하는 리튬이온 배터리는 위험물 관련 규정을 따릅니다. 배터리는 별도의 요구 사항 없이 사용자가 직접 도로 상에서 운반할 수 있습니다.

제3자를 통해 운반할 경우(항공 운송이나 운송 회사 등) 포장과 표기에 관한 특별한 요구 사항을 준수해야 합니다. 이 경우 발송 준비를 위해 위험물 전문가와 상담해야 합니다.

표면이 손상되지 않은 배터리만 사용하십시오. 배터리의 접촉 단자면을 덮어 붙인 상태로 내부에서 움직이지 않도록 배터리를 포장하십시오. 또한 이와 관련한 국내 규정을 준수하십시오.

## 처리



측정공구, 충전용 배터리/배터리, 액세서리 및 포장은 친환경적으로 재활용됩니다.



측정공구 및 충전용 배터리/배터리를 가정용 쓰레기에 버리지 마십시오!

### 충전용 배터리/배터리:

#### 리튬이온:

운반 단락에 나와 있는 지침을 참고하십시오 (참조 „운반“, 페이지 140)을 누르십시오.

## 액세서리

제시된 링크를 통해 보쉬 웹사이트에서 액세서리를 확인할 수 있습니다.

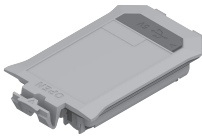

BA 3.7V 1.0Ah A (19)  
1 608 M00 C5D

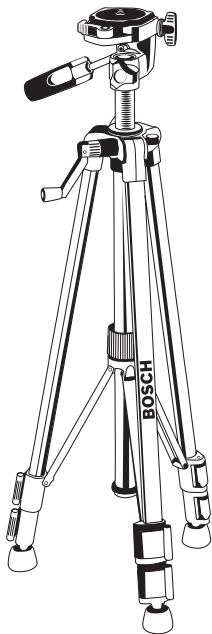

삼각대 BT 150 (25)  
0 601 096 B00

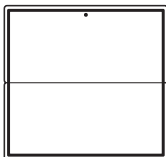

레이저 표적판 (26)  
2 607 001 391



레이저용 안경(녹색) (27)  
1 608 M00 05J

## ไทย

### กฎระเบียบเพื่อความปลอดภัย



ส่งเครื่องมือวัดให้ช่างผู้เชี่ยวชาญตรวจ  
ซ่อมและใช้อะไหล่เปลี่ยนของแท้เท่านั้น หากไม่ใช่เครื่อง  
มือวัดตามคำแนะนำเหล่านี้ ระบบป้องกันเบ็ดเสร็จในเครื่อง

มือวัดอาจได้รับผลกระทบ อย่าทำให้ป้ายเตือนที่อยู่บนเครื่องมือวัดนี้ลบเลือน เก็บ  
รักษาคำแนะนำเหล่านี้ไว้ให้ดี และหากเครื่องมือวัดนี้ถูกส่งต่อไปยังผู้อื่น ให้ส่งมอบคำ  
แนะนำเหล่านี้ไปด้วย

- ▶ ข้อควรระวัง - การใช้อุปกรณ์ทำงานหรืออุปกรณ์ปรับเปลี่ยนอื่นๆ นอกเหนือไปจาก  
ที่ระบุไว้ในที่นี่ หรือการใช้วิธีการอื่นๆ อาจนำไปสู่การสัมผัสกับรังสีอันตรายได้
- ▶ เครื่องมือวัดนี้จัดส่งมาพร้อมป้ายเตือนแสงเลเซอร์ (แสดงในหน้าภาพประกอบของ  
เครื่องมือวัด)
- ▶ หากข้อความของป้ายเตือนแสงเลเซอร์ไม่ได้เป็นภาษาของท่าน ให้ติดสติ๊กเกอร์ที่  
จัดส่งมาที่พิมพ์เป็นภาษาของท่านทับลงบนข้อความก่อนใช้งานครั้งแรก



อย่าเสีงแสงเลเซอร์ไปยังคนหรือสัตว์ และตัวท่านเองอย่างจ้องมอง  
เข้าไปในลำแสงเลเซอร์โดยตรงหรือลำแสงเลเซอร์สะท้อน การกระทำ  
ดังกล่าวอาจทำให้คนตาพร่า ทำให้เกิดอุบัติเหตุ หรือทำให้ดวงตเสียหายได้

- ▶ ถ้าแสงเลเซอร์เข้าตา ต้องปิดตาและหันศีรษะออกจากลำแสงในทันที
- ▶ อย่าทำการเปลี่ยนแปลงใดๆ ที่อุปกรณ์เลเซอร์
- ▶ ส่งเครื่องมือวัดให้ช่างผู้เชี่ยวชาญตรวจสอบและไขอะไหล่เปลี่ยนของแท้เท่านั้น  
ทั้งนี้เพื่อให้มั่นใจได้ว่าจะสามารถใช้งานเครื่องมือวัดได้อย่างปลอดภัยเสมอ
- ▶ อย่าให้เด็กใช้เครื่องมือวัดด้วยเลเซอร์โดยไม่ควบคุมดูแล เด็กๆ อาจทำให้บุคคลอื่น  
หรือตนเองตาพร่าโดยไม่ตั้งใจ
- ▶ อย่าใช้เครื่องมือวัดในสภาพแวดล้อมที่เสี่ยงต่อการระเบิด ซึ่งเป็นที่มีของเหลว  
แก๊ซ หรือฝุ่นที่ติดไฟได้ ในเครื่องมือวัดสามารถเกิดประกายไฟซึ่งอาจจุดฝุ่นละออง  
หรือไอระเหยให้ติดไฟได้
- ▶ อย่าเปิดแบตเตอรี่ อันตรายจากการลัดวงจร
- ▶ เมื่อแบตเตอรี่ชาร์ตและนำไปใช้งานอย่างไม่ถูกต้องอาจมีไอระเหยออกมาได้  
แบตเตอรี่อาจเผาไหม้หรือระเบิดได้ให้สูดอากาศบริสุทธิ์และไปพบแพทย์ในกรณีเจ็บ  
ปวด ไอระเหยอาจทำให้ระบบหายใจระคายเคือง
- ▶ หากใช้อย่างไม่ถูกต้องหรือหากแบตเตอรี่ชาร์ต ของเหลวไวไฟ  
อาจไหลออกมาจากแบตเตอรี่ได้ หลีกเลี่ยงการสัมผัสของเหลว ในกรณีสัมผัสโดย  
ไม่ตั้งใจ ให้ล้างออกด้วยน้ำ หากของเหลวเข้าตา ให้ไปพบแพทย์ด้วย  
ของเหลวที่ไหลออกมาจากแบตเตอรี่อาจทำให้เกิดอาการคันหรือแสบผิวหนังได้
- ▶ วัตถุที่แหลมคม ต. ย. เช่น ตะปูหรือไขควง หรือแรงกระทำภายนอก อาจทำให้  
แบตเตอรี่เสียหายได้ สิ่งเหล่านี้อาจทำให้เกิดการลัดวงจรภายในและแบตเตอรี่ใหม่ มี  
ควัน ระเบิด หรือร้อนเกินไป



- ▶ นำแบตเตอรี่ที่ไม่ได้ใช้งานออกจากคลังปืนในระยะยาว เหยี่ยง ฤญแจ ตะปู สกรู หรือวัตถุโลหะขนาดเล็กอื่นๆ ที่สามารถเชื่อมต่อขั้วหนึ่งไปยังอีกขั้วหนึ่งได้ การลัดวงจรของขั้วแบตเตอรี่อาจทำให้เกิดการไหม้หรือไฟลุกได้
- ▶ ใช้แบตเตอรี่แพ็คเกจเฉพาะในผลิตภัณฑ์ของผู้ผลิตเท่านั้น ในลักษณะนี้ แบตเตอรี่แพ็คเกจ จะได้รับการปกป้องจากการใช้งานเกินกำลังซึ่งเป็นอันตราย
- ▶ ชาร์จแบตเตอรี่แพ็คเกจด้วยเครื่องชาร์จที่บริษัทผู้ผลิตแนะนำเท่านั้น เครื่องชาร์จที่เหมาะสมสำหรับชาร์จแบตเตอรี่ประเภทหนึ่ง หากนำไปชาร์จแบตเตอรี่ประเภทอื่น อาจเกิดไฟไหม้ได้



ปกป้องแบตเตอรี่จากความร้อน รวมทั้ง ต. ย. เช่น จากการถูกแสงแดดส่องต่อเนื่อง จากไฟ สิ่งสกปรก น้ำ และความชื้น อันตรายจากการระเบิดและการลัดวงจร

- ▶ อย่าใช้แว่นสำหรับมองแสงเลเซอร์ (อุปกรณ์เสริม) เป็นแว่นนิรภัย แว่นสำหรับมองแสงเลเซอร์ใช้สำหรับมองลำแสงเลเซอร์ให้เห็นชัดเจนยิ่งขึ้น แต่ไม่ได้ช่วยป้องกันรังสีเลเซอร์
- ▶ อย่าใช้แว่นสำหรับมองแสงเลเซอร์ (อุปกรณ์เสริม) เป็นแว่นกันแดดหรือใส่ขั้วรถยนต์แว่นสำหรับมองแสงเลเซอร์ไม่สามารถป้องกันรังสีอัลตราไวโอเล็ต (UV) ได้ อย่างสมบูรณ์ และยังลดความสามารถในการมองเห็นสี
- ▶ เครื่องมือวัดมีอินเทอร์เฟซคลื่นวิทยุสำหรับเชื่อมโยงสื่อสารแบบไร้สายต้องปฏิบัติตามข้อจำกัดการทำงานในพื้นที่ ต. ย. เช่น ในเครื่องบิน หรือโรงพยาบาล เครื่องหมายข้อความ *Bluetooth*® และยี่ห้อเป็นเครื่องหมายการค้าจดทะเบียนและเป็นกรรมสิทธิ์ของ Bluetooth SIG, Inc. บริษัท Robert Bosch Power Tools GmbH ได้รับใบอนุญาตใช้งานเครื่องหมายข้อความ/โลโก้ดังกล่าว
- ▶ ระวัง! การใช้เครื่องมือไฟฟ้าที่มี *Bluetooth*® อาจรบกวนอุปกรณ์และเครื่องมืออื่นๆ เครื่องบิน และอุปกรณ์ทางการแพทย์ (ต. ย. เช่น เครื่องกระตุ้นหัวใจ เครื่องช่วยฟัง) นอกจากนี้ยังอาจเกิดความเสียหายต่อคนและสัตว์ในบริเวณใกล้เคียงด้วย อย่าใช้

เครื่องมือวัดที่มี Bluetooth® โกลั่ อุปกรณ์ทางการแพทย์ สถานให้บริการน้ำมัน  
โรงงานเคมี พื้นที่ที่เสี่ยงต่อการระเบิด และในพื้นที่ทำการระเบิด อย่าใช้เครื่องมือ  
ไฟฟ้าที่มี Bluetooth® ในเครื่องบิน หลีกเลี่ยงการใช้งานเป็นระยะเวลาานตรง  
บริเวณใกล้ร่างกายโดยตรง

## คำเตือนเพื่อความปลอดภัยสำหรับเพาเวอร์ซัพพลาย

- ▶ ปลั๊กอะแดปเตอร์ AC นี้ไม่ได้มีไว้เพื่อการใช้งานโดยเด็กและบุคคลที่มีความบกพร่องทางกายภาพ ทางประสาทสัมผัส หรือทางจิตใจ หรือบุคคลที่ขาดประสบการณ์และความรู้ เด็กอายุตั้งแต่ 8 ปีขึ้นไปและบุคคลที่มีความบกพร่องทางกายภาพ ทางประสาทสัมผัส หรือทางจิตใจ หรือขาดประสบการณ์และความรู้สามารถไขปลั๊กอะแดปเตอร์ AC นี้ได้ หากได้รับการควบคุมดูแลจากบุคคลที่รับผิดชอบความปลอดภัยของพวกเขาหรือได้รับคำแนะนำขั้นตอนการใช้งานปลั๊กอะแดปเตอร์ AC อย่างปลอดภัยและเข้าใจถึงอันตรายที่เกี่ยวข้อง มิฉะนั้นจะมีอันตรายจากความผิดพลาดในการปฏิบัติงานและได้รับบาดเจ็บ

 อย่าวางปลั๊กอะแดปเตอร์ AC ตกฝนหรือทิ้งไว้ในที่ชื้นแฉะ หากน้ำเข้าไปในปลั๊กอะแดปเตอร์ AC จะเพิ่มความเสี่ยงต่อการถูกไฟฟ้าดูด

- ▶ รักษาปลั๊กอะแดปเตอร์ AC ให้สะอาด ความสกปรกอาจเป็นสาเหตุให้ถูกไฟฟ้าดูด
- ▶ ตรวจสอบสถานีชาร์จก่อนใช้งานปลั๊กอะแดปเตอร์ AC ทุกครั้ง อย่าไขปลั๊กอะแดปเตอร์ AC หากท่านสังเกตเห็นความเสียหาย อย่าเปิดปลั๊กอะแดปเตอร์ AC ด้วยตัวเองและให้ Bosch หรือศูนย์บริการที่ได้รับอนุญาตเชี่ยวชาญตรวจสอบและใช้อะไหล่เปลี่ยนของแท้เท่านั้น เปิดปลั๊กอะแดปเตอร์ AC ที่ชำรุดจะเพิ่มความเสี่ยงต่อการถูกไฟฟ้าดูด

## รายละเอียดผลิตภัณฑ์และข้อมูลจำเพาะ

### ประโยชน์การใช้งาน

เครื่องมือวัดนี้ใช้สำหรับวัดระยะทาง ความยาว ความสูง ช่องว่าง ความลาดชัน และสำหรับคำนวณพื้นที่และปริมาตร

เครื่องมือวัดนี้เหมาะสำหรับใช้ภายในอาคาร

ผลจากการวัดสามารถถ่ายโอนไปยังอุปกรณ์อื่นๆ ผ่าน Bluetooth®

### ส่วนประกอบที่แสดงภาพ

ลำดับเลขของส่วนประกอบผลิตภัณฑ์อ้างอิงถึงส่วนประกอบของเครื่องมือวัดที่แสดงในหน้าภาพประกอบ

- (1)  ปุ่ม Bluetooth®
- (2)  ปุ่มฟังก์ชัน
- (3)  ปุ่มลบ
- (4) จอแสดงผล
- (5)  ปุ่มวัด
- (6)  ปุ่มบวก
- (7)  ปุ่มการตั้งค่าพื้นฐานต่างๆ
- (8)  ปุ่มเปิด/ปิด/ย้อนกลับ
- (9) ส่วนรองรับสายหิ้ว
- (10) ป้ายเตือนแสงเลเซอร์
- (11) หมายเลขเครื่อง

- (12) ตัวล็อกฝาช่องใส่แบตเตอรี่
- (13) ฝาช่องใส่แบตเตอรี่
- (14) เกลียขาตั้งแบบสามขา 1/4"
- (15) เลนส์รับแสง
- (16) ทางออกลำแสงเลเซอร์
- (17) สายทีวี<sup>A)</sup>
- (18) กระจ่างใส่เครื่องมือวัด
- (19) ชุดแบตเตอรี่ลิเทียมไอออน<sup>A)</sup>
- (20) ตัวล็อกชุดแบตเตอรี่ลิเทียมไอออน<sup>A)</sup>
- (21) สาย USB Type-C<sup>®A)B)</sup>
- (22) ฝาครอบพอร์ต USB<sup>A)</sup>
- (23) คลิปหนีบเข็มขัด<sup>A)</sup>
- (24) สกรูสำหรับคลิปหนีบเข็มขัด<sup>A)</sup>
- (25) ขาตั้งแบบสามขา<sup>A)</sup>
- (26) แผ่นเบ้าเล็งเลเซอร์<sup>A)</sup>
- (27) แวนตาสำหรับมองแสงเลเซอร์<sup>A)</sup>

A) อุปกรณ์ประกอบที่แสดงภาพหรืออธิบายไม่รวมอยู่ในการจัดส่งมาตรฐาน  
กรุณาดูอุปกรณ์ประกอบทั้งหมดในรายการแสดงอุปกรณ์ประกอบของเรา

B) USB Type-C<sup>®</sup> และ USB-C<sup>®</sup> เป็นเครื่องหมายการค้าของ USB Implementers Forum

### ชิ้นส่วนแสดงผล

- (a) ระบุอ้างอิงของการวัด

- (b) สถานะ *Bluetooth*<sup>®</sup>
- \* *Bluetooth*<sup>®</sup> เปิดการทำงาน แต่ยังไม่ได้สร้างการเชื่อมต่อ
  - \* *Bluetooth*<sup>®</sup> ถูกเรียกใช้งาน มีการเชื่อมต่อ
- (c) ไฟแสดงสถานะแบตเตอรี่
- (d) บรรทัดแสดงค่าจากการวัด
- (e) บรรทัดผลลัพธ์
- (f) ไฟแสดงฟังก์ชันการวัด
- (g) สัญลักษณ์ มุมเอียง
- (h) แถบสถานะ
- (i) เมนูฟังก์ชันต่างๆ
- (j) เมนูการตั้งค่าพื้นฐานต่างๆ
- (k) เมนูการตั้งค่าพื้นฐานอื่นๆ

## ข้อมูลทางเทคนิค

เครื่องวัดระยะด้วยเลเซอร์แบบคิจิตอล	GLM 50-27 CG
หมายเลขสินค้า	3 601 K72 U..
ขอบเขตการวัด <sup>A)</sup>	0.05–50 ม.
ช่วงการวัด (สถานะที่ไม่เหมาะสม) <sup>B)</sup>	0.05–20 ม.
ความแม่นยำการวัด <sup>A)</sup>	± 1.5 มม.
ความแม่นยำการวัด (สถานะที่ไม่เหมาะสม) <sup>B)</sup>	± 3.0 มม.
หน่วยแสดงการวัดต่ำสุด	0.5 มม.
<b>ทั่วไป</b>	
อุณหภูมิใช้งาน <sup>C)</sup>	-10°C ... +45°C
อุณหภูมิเก็บรักษา	-20°C ... +70°C

เครื่องวัดระยะด้วยเลเซอร์แบบดิจิทัล	GLM 50-27 CG
ความขึ้นล้มที่สูงสุด	90 %
ความสูงใช้งานเหนือระดับอ้างอิงสูงสุด	2000 ม.
ระดับมลพิษตาม IEC 61010-1	2 <sup>D)</sup>
ระดับเลเซอร์	2
ชนิดเลเซอร์	515 นาโนเมตร, < 1 มิลลิวัตต์
ความแตกต่างของลำแสงเลเซอร์	< 1.5 mrad (มุมเต็ม)
วิธีการทำงานอัตโนมัติหลังจากผ่านไปประมาณ	
- เลเซอร์	20 วินาที
- เครื่องมือวัด (เมื่อไม่มีการวัด) <sup>E)</sup>	5 นาที
<b>การวัดระยะทางอ้อมและระดับน้ำ</b>	
ขอบเขตการวัด	0°-360° (4 × 90°)
<b>การวัดความลาดชัน</b>	
ขอบเขตการวัด	0°-360° (4 × 90°)
ความแม่นยำการวัด <sup>F)</sup>	± 0.2°
หน่วยแสดงการวัดต่ำสุด	0.1°
น้ำหนักตามระเบียบการ EPTA-Procedure 01:2014	0.17 กก.
ระดับการคุ้มกัน	IP 65 (ป้องกันฝุ่นและน้ำกระเซ็น)
ขนาด	119 × 53 × 29 มม.
การตั้งค่าหน่วยของการวัด	เมตร, ฟุต, นิ้ว
แบตเตอรี่	2 × 1.5 โวลต์ LR6 (AA)
<b>แบตเตอรี่แพ็ค (อุปกรณ์เสริม)</b>	<b>ลิเทียมไอออน</b>
ประเภท	BA 3.7V 1.0Ah A
หมายเลขสินค้า	<b>1 607 A35 17H</b>
พอร์ตชาร์จ USB	Type-C®
แรงดันไฟฟ้าที่กัก	3.7 โวลต์ ---
ความจุ	1.0 Ah
จำนวนเซลล์แบตเตอรี่	1

## เครื่องวัดระยะด้วยเลเซอร์แบบดิจิทัล

GLM 50-27 CG

ช่วงอุณหภูมิที่อนุญาตให้ชาร์จ

+10 °C ... +35 °C

## ปลั๊กจ่ายไฟฟ้า

แรงดันเอาต์พุต

5.0 โวลต์ ---

กระแสไฟขาออกขั้นต่ำ

500 mA

## การถ่ายโอนข้อมูล

Bluetooth®

Bluetooth® 4.2  
(Low Energy)<sup>(H)</sup>

ย่านความถี่ใช้งาน

2402–2480 เมกะเฮิรตซ์

กำลังส่งสูงสุด

8 มิลลิวัตต์

- A) การวัดจากขอบหน้าของเครื่องมือวัดจะใช้ในกรณีที่เป็นเหลี่ยมที่เป่าหยาบสะท้อนแสงได้มาก (เช่น ผงที่ทาสีขาว), พื้นหลังอ่อน และอุณหภูมิการทำงานอยู่ที่ 20 °C นอกจากนี้ให้คำนวณค่าความเบี่ยงเบนที่ขึ้นอยู่กับระยะทางเพิ่มเติมอีก  $\pm 0.05$  มม./ม.
- B) การวัดจากขอบหน้าของเครื่องมือวัดจะใช้ในกรณีที่เป็นเหลี่ยมที่เป่าหยาบสะท้อนแสงได้มาก (เช่น ผงที่ทาสีขาว), พื้นหลังเข้ม, อุณหภูมิการทำงานอยู่ที่ 20 °C และอยู่ในพื้นที่สูง นอกจากนี้ให้คำนวณค่าความเบี่ยงเบนที่ขึ้นอยู่กับระยะทางเพิ่มเติมอีก  $\pm 0.15$  มม./ม.
- C) ในฟังก์ชันการวัดต่อเนื่องอุณหภูมิใช้งานสูงสุดคือ +40 °C
- D) เกิดขึ้นเฉพาะมลพิษที่ไม่นำไฟฟ้า ยกเว้นบางครั้งนำไฟฟ้าได้ชั่วคราวที่มีสาเหตุจากการกลั่นตัวที่คาดการณ์ว่าจะเกิดขึ้น
- E) Bluetooth® ปิดใช้งานอยู่
- F) ที่อุณหภูมิใช้งาน 25 °C
- G) หลังการสอบเทียบของผู้ใช้งานที่ 0° และ 90° ต้องนำข้อผิดพลาดความชื้นเพิ่มเติมจาก  $\pm 0.01$  / องศาถึง 45° (สูงสุด) มาพิจารณา สำหรับการวัดความลาดชัน ให้ใช้ด้านข้างของเครื่องมือวัดเป็นระนาบอ้างอิง
- H) สำหรับอุปกรณ์ Bluetooth® Low Energy อาจไม่มีการเชื่อมต่อ ทั้งนี้ขึ้นอยู่กับรุ่นและระบบปฏิบัติการ อุปกรณ์ Bluetooth® ต้องสนับสนุน GATT-Profile

หมายเลขเครื่อง (11) บนแผ่นป้ายรุ่นสามารถระบุเครื่องมือวัดของท่านได้อย่างชัดเจน

## การใส่/การเปลี่ยนแบตเตอรี่

ขอแนะนำให้ใช้แบตเตอรี่อัลคาไลน์-แมงกานีสหรือแบตเตอรี่ที่ไม่ใช่อัลคาไลน์-แมงกานีสสำหรับการทำงานของเครื่องมือวัด (โดยเฉพาะอย่างยิ่งในอุณหภูมิการทำงานต่ำ) แบตเตอรี่แพ็ค 1.2 โวลท์ จะวัดได้น้อยกว่าแบตเตอรี่ 1.5 โวลท์ ทั้งนี้ขึ้นอยู่กับความจุของแบตเตอรี่

- » เปิดฝาช่องใส่แบตเตอรี่
- » ใส่แบตเตอรี่หรือแบตเตอรี่แพ็คเข้าไป

- (i) เปลี่ยนแบตเตอรี่หรือแบตเตอรี่แพ็คทุกก้อนพร้อมกันเสมอ โดยใช้แบตเตอรี่หรือแบตเตอรี่แพ็คจากผู้ผลิตรายเดียวกันทั้งหมดและมีความจุเท่ากันทุกก้อน
- (i) ขณะใส่แบตเตอรี่ต้องดูให้ขั้วแบตเตอรี่อยู่ในตำแหน่งที่ถูกต้องตามที่กำหนดไว้ที่ด้านในช่องใส่แบตเตอรี่

หากแบตเตอรี่หรือแบตเตอรี่แพ็คมีประจุคงเหลือน้อยขอความถามเพื่อเปิดใช้งานโหมดประหยัดแบตเตอรี่จะปรากฏบนหน้าจอ ในโหมดประหยัดแบตเตอรี่ อายุการใช้งานแบตเตอรี่จะขยายออกไปและสัญลักษณ์แบตเตอรี่ในจอแสดงผลจะเป็นสีเหลือง (ดู "การเปิด/ปิดใช้งานโหมดประหยัดแบตเตอรี่" , หน้า 159)

หากสัญลักษณ์แบตเตอรี่ที่ว่างเปล่าปรากฏบนจอแสดงผลเป็นครั้งแรก ยังสามารถวัดได้อีกประมาณไม่กี่ครั้งเท่านั้น

หากสัญลักษณ์แบตเตอรี่ที่ว่างเปล่าและกะพริบสีแดง ท่านไม่สามารถทำการวัดได้อีกต่อไป ให้เปลี่ยนแบตเตอรี่หรือแบตเตอรี่แพ็ค

▶ **เมื่อไม่ใช้งานเป็นเวลานาน ให้ถอดแบตเตอรี่หรือแบตเตอรี่แพ็คออกจากเครื่องมือวัดเมื่อเก็บเป็นเวลานาน แบตเตอรี่หรือแบตเตอรี่แพ็คจะเกิดการกัดกร่อนและคายประจุไฟออกมาเอง**

- (i) ห้ามจัดเก็บเครื่องมือวัดโดยไม่ปิดฝาช่องใส่แบตเตอรี่ (13) หรือไม่ใส่ชุดแบตเตอรี่ลิเทียมไอออน (19) (อุปกรณ์เสริม) โดยเด็ดขาด โดยเฉพาะอย่างยิ่งในสภาพแวดล้อมที่มีฝุ่นหรือเปียกชื้น



## ชุดแบตเตอรี่ลิเธียมไอออน (อุปกรณ์เสริม)

### การใส่/การเปลี่ยนชุดแบตเตอรี่ลิเธียมไอออน (อุปกรณ์เสริม)

- » ใส่ชุดแบตเตอรี่ลิเธียมไอออน (19) (อุปกรณ์เสริม)
- » สำหรับการนำชุดแบตเตอรี่ลิเธียมไอออน (19) (อุปกรณ์เสริม) ออก ให้กดตัวล็อก (20) แล้วนำชุดแบตเตอรี่ลิเธียมไอออนออกมา (ดู ภาพประกอบ A, หน้า 4)

### การชาร์จชุดแบตเตอรี่ลิเธียมไอออน (อุปกรณ์เสริม)

- ▶ สำหรับชาร์จ ให้ใช้อะแดปเตอร์แปลงไฟ USB ที่แนะนำหรืออะแดปเตอร์แปลงไฟที่มีแรงดันเอาต์พุตและกระแสไฟขาออกขึ้นต่่าตรงตามข้อกำหนดในบท "ข้อมูลทางเทคนิค" ปฏิบัติตามคู่มือการใช้งานสำหรับอะแดปเตอร์แปลงไฟ USB อะแดปเตอร์แปลงไฟที่แนะนำ: ดู "ข้อมูลทางเทคนิค"
- ▶ **ให้สังเกตแรงดันไฟฟ้า!** แรงดันไฟฟ้าจากแหล่งจ่ายไฟต้องมีค่าตรงกับค่าแรงดันไฟฟ้าที่ระบุไว้บนแผ่นป้ายพิกัดปลั๊กจ่ายไฟ ปลั๊กจ่ายไฟที่มีเครื่องหมาย 230 โวลต์ สามารถใช้งานกับแรงดันไฟฟ้า 220 โวลต์ ได้ด้วย

**i** แบตเตอรี่ลิเธียมไอออนจะจัดส่งโดยได้รับการชาร์จเพียงบางส่วนเนื่องด้วยข้อกำหนดด้านการขนย้ายระหว่างประเทศ เพื่อให้แบตเตอรี่สามารถทำงานได้เต็มประสิทธิภาพ ให้ชาร์จแบตเตอรี่จนเต็มก่อนใช้งานเป็นครั้งแรก

ซ็อกเก็ต USB สำหรับเชื่อมต่อสาย USB (21) และไฟแสดงสถานะการชาร์จจะอยู่ใต้ฝาคอโรนซ็อกเก็ต USB (22) ที่ชุดแบตเตอรี่ลิเธียมไอออน (19) (อุปกรณ์เสริม)

- » เปิดฝาคอโรนซ็อกเก็ต USB (22)
- » เชื่อมต่อสาย USB (21)

ไฟแสดงสถานะแบตเตอรี่บนจอแสดงผลอาจเบี่ยงเบนจากสถานะการชาร์จจริงของชุดแบตเตอรี่ลิเธียมไอออน (19) (อุปกรณ์เสริม) ในระหว่างกระบวนการชาร์จ

ไฟแสดงระดับการชาร์จจะติดสว่างเป็นสีเหลืองในระหว่างชาร์จ

เมื่อชุดแบตเตอรี่ลิเธียมไอออน (19) (อุปกรณ์เสริม) ได้รับการชาร์จจนเต็มแล้ว ไฟแสดงระดับการชาร์จจะติดสว่างเป็นสีเขียว

ไฟแสดงระดับการชาร์จสีแดงเป็นสัญญาณบ่งบอกว่าแรงดันไฟชาร์จหรือกระแสไฟชาร์จไม่เหมาะสม



## การปฏิบัติงาน

### การเริ่มต้นปฏิบัติงาน

- ▶ **อย่าวางเครื่องมือวัดที่เปิดสวิตช์ทิ้งไว้โดยไม่มีผู้ดูแลและปิดสวิตช์เครื่องมือวัดเมื่อเลิกใช้งาน** คนอื่นอาจตาพร่าจากแสงเลเซอร์ได้
- ▶ **ป้องกันไม่ให้เครื่องมือวัดได้รับความชื้นและโดนแสงแดดส่องโดยตรง**
- ▶ **อย่าให้เครื่องมือวัดได้รับอุณหภูมิที่สูงมาก หรือรับอุณหภูมิที่เปลี่ยนแปลงมาก** ต. ย. เช่น อย่าย้ายเครื่องมือวัดในรถยนต์เป็นเวลานาน ในกรณีที่อุณหภูมิมีการเปลี่ยนแปลงมาก ต้องปล่อยให้เครื่องมือวัดปรับตัวเข้ากับอุณหภูมิรอบด้านก่อนใช้งาน ในกรณีที่ได้รับอุณหภูมิที่สูงมากหรือรับอุณหภูมิที่เปลี่ยนแปลงมาก เครื่องมือวัดอาจมีความแม่นยำน้อยลง
- ▶ **หลีกเลี่ยงอย่าให้เครื่องมือวัดตกหล่นหรือถูกกระแทกอย่างรุนแรง** เมื่อเครื่องมือวัดถูกกระแทกจากภายนอกอย่างรุนแรง ขอแนะนำให้ทำการตรวจสอบความแม่นยำ (ดู "การตรวจสอบความแม่นยำ", หน้า 176) ทุกครั้งก่อนนำมาใช้งานต่อ



### การเปิด-ปิดเครื่อง

» กดปุ่ม  เพื่อเปิดเครื่องมือวัดและเลเซอร์

- คุณยังสามารถเปิดเครื่องมือวัดโดยไม่ต้องใช้เลเซอร์ได้โดยกดปุ่ม 
- » กดปุ่ม  ค้างไว้เพื่อปิดเครื่องมือวัด  
ค่าและการตั้งค่าอุปกรณ์ที่บันทึกไว้ในหน่วยความจำจะยังคงอยู่

## วิธีดำเนินการวัด



เมื่อเปิดสวิตช์ครั้งเดียว เครื่องมือวัดจะอยู่ในฟังก์ชันการวัดความยาว ทุกครั้งเมื่อเปิดสวิตช์ เครื่องมือวัดจะอยู่ในโหมดล่าสุดที่ใช้งาน  
ระนาบอ้างอิงในการวัดมีการตั้งค่าที่สามารถใช้งานได้สามารถ (ดู "เลือกระนาบอ้างอิง", หน้า 156)

- » วางเครื่องมือวัดที่จุดเริ่มต้นที่ต้องการวัด (ต. ย. เช่น ผนังห้อง)
- » หากคุณเปิดใช้งานเครื่องมือวัดโดยใช้ปุ่ม  ให้กดปุ่ม  แล้วปล่อยเพื่อเปิดใช้งานเลเซอร์
- » กดปุ่ม  เพื่อเรียกการวัด

ลำแสงเลเซอร์จะปิดหลังกระบวนการวัด สำหรับการวัดต่อไปให้ทำซ้ำขั้นตอนนี้  
ท่านสามารถเพิ่มหรือลดค่าจากการวัดหรือผลลัพธ์สุดท้ายได้

โดยทั่วไปค่าจากการวัดจะปรากฏภายใน 0.5 วินาที และหลังจากเวลาผ่านไปประมาณ 4 วินาทีเป็นอย่างช้าที่สุด

ระยะเวลาที่ใช้ในการวัดขึ้นอยู่กับระยะทาง สภาพแสง และคุณสมบัติการสะท้อนของพื้นผิวเป้าหมาย ลำแสงเลเซอร์จะปิดอัตโนมัติหลังกระบวนการวัด

-  เครื่องมือวัดต้องไม่ขยับในระหว่างวัด (ยกเว้นฟังก์ชันการวัดอย่างต่อเนื่องและการวัดความเอียง) หากเป็นไปได้ ให้วางเครื่องมือวัดไว้บนพื้นหรือพื้นผิวรองรับที่มั่นคง
-  เลนส์รับ (15) และช่องปล่อยลำแสงเลเซอร์ (16) ต้องไม่ถูกบดบังในระหว่างการวัด

## อิทธิพลต่อช่วงการวัด

ช่วงการวัดขึ้นอยู่กับระยะทาง สภาพแสง และคุณสมบัติการสะท้อนของพื้นผิวเป้าหมาย

คุณสมบัติการสะท้อนแสงของพื้นผิวชิ้นงานเพื่อการมองเห็นที่ดีขึ้นของลำแสงเลเซอร์ในแสงภายนอกที่รุนแรง (27) (อุปกรณ์เสริม) และแผ่นเป้าหมายเลเซอร์ (26) (อุปกรณ์เสริม) หรือแรงผลักดันเป้าหมาย

### อิทธิพลต่อผลลัพธ์จากการวัด

เนื่องจากผลกระทบทางกายภาพ จึงไม่สามารถบ่งบอกได้ว่าการวัดที่ไม่ถูกต้องจะเกิดขึ้นเมื่อทำการวัดบนพื้นผิวต่างๆ ซึ่งรวมถึง:

- พื้นผิวโปร่งใส (เช่น แก้ว น้ำ),
- พื้นผิวสะท้อนแสง (เช่น โลหะขัดเงา แก้ว),
- พื้นผิวที่มีรูพรุน (เช่น วัสดุฉนวน),
- พื้นผิวที่มีโครงสร้าง (เช่น ปูนฉาบหยาบ หินธรรมชาติ)

หากจำเป็น ให้ใช้แผ่นเป้าหมายเลเซอร์ (26) (อุปกรณ์เสริม) บนพื้นผิวเหล่านี้ นอกจากนี้ยังสามารถวัดค่าที่ไม่ถูกต้องในพื้นที่เป้าหมายที่ห้ามุมได้ ขึ้นอากาศที่มีอุณหภูมิต่างกันหรือแสงสะท้อนที่ได้รับทางอ้อมอาจส่งผลต่อค่าที่วัดได้

### การนำทางในเมนู

ในเมนู คุณสามารถกลับไปทางขวาด้วยปุ่ม  และไปทางซ้ายได้ด้วยปุ่ม 

ยืนยันการเลือก โดยกดปุ่ม  หรือปุ่ม 

ออกจากเมนูโดยกดปุ่ม 

### เลือกระนาบอ้างอิง

สำหรับการวัดท่านสามารถเลือกระนาบอ้างอิงได้หลายลักษณะ:







ขอบหลังของเครื่องมือวัด (เช่น เมื่อวางบนผนังห้อง)



จุดศูนย์กลางเกสียวชาตังแบบสามขา (14) (เช่น สำหรับการวัดด้วยขาตังแบบสามขา)













ขอบหน้าของเครื่องมือวัด (เช่น เมื่อวัดจากขอบโต๊ะ เป็นต้นไป)

- » กดปุ่ม  เพื่อเปิดเมนูการตั้งค่าพื้นฐานต่างๆ
- » เลือก 
- » เลือกระนาบอ้างอิงที่ต้องการโดยใช้ปุ่ม  หรือปุ่ม 
- » เพื่อยืนยันการเลือก โดยกดปุ่ม 

ทุกครั้งที่เปิดสวิตช์เครื่องมือวัดระดับอ้างอิงจะปรับไปอยู่ที่ระนาบอ้างอิงที่เลือกล่าสุด ทั้งนี้ไม่สามารถเปลี่ยนแปลงระนาบอ้างอิงของการวัดที่ดำเนินการแล้วในภายหลังได้ (เช่น เมื่อมีการแสดงค่าที่วัดได้ในรายการค่าที่วัดได้)

## เมนูการตั้งค่าพื้นฐานต่างๆ

ในเมนู การตั้งค่าพื้นฐานต่างๆ จะพบการตั้งค่าพื้นฐานต่างๆ ดังนี้:





-  การเลือกระนาบอ้างอิง (ดู "เลือกระนาบอ้างอิง", หน้า 156)
-  การเปิด/ปิดใช้งานสัญญาณเสียง
-  การสั่นเปิด/ปิด
-  การตั้งค่าความสว่างหน้าจอ
-  การเปิด/ปิดใช้งานโหมดประหยัดแบตเตอรี่
-  การเปลี่ยนหน่วยของการวัด
-  การกำหนดภาษา
-  การสอบเทียบการวัดความเอียง (ดู "การตรวจสอบความแม่นยำ", หน้า 176)
-  การเรียกใช้งานข้อมูลอุปกรณ์
-  การตั้งค่าจากโรงงาน
-  การลบหน่วยความจำ

- » กดปุ่ม  เพื่อเปิดเมนูการตั้งค่าพื้นฐานต่างๆ

- » เลือกการตั้งค่าที่คุณต้องการได้ด้วยปุ่ม ► หรือปุ่ม ◀
- » ยืนยันการเลือก โดยกดปุ่ม Func หรือปุ่ม ▲
- » กดปุ่ม ⏪ แล้วปล่อยเพื่อออกจากเมนูการตั้งค่าพื้นฐานต่างๆ

### การเปิด/ปิดใช้งานสัญญาณเสียง





ในการตั้งค่าพื้นฐาน เสียงจะถูกเปิดใช้งานอยู่แล้ว

- » กดปุ่ม  เพื่อเรียกดูเมนูการตั้งค่าพื้นฐานต่างๆ 
- » เลือก 
- » กดปุ่ม ► หรือปุ่ม ◀ เพื่อเปลี่ยนการเลือก
- » ยืนยันการเลือก โดยกดปุ่ม ▲ หรือปุ่ม Func
- » กดปุ่ม ⏪ แล้วปล่อยเพื่อออกจากเมนูการตั้งค่าพื้นฐานต่างๆ   
เมื่อปิดสวิตช์เครื่องมือวัดค่าที่เลือกจะยังคงถูกเก็บไว้

### การสั่นเปิด/ปิด









ในการตั้งค่าพื้นฐาน การสั่นจะถูกเปิดใช้งานอยู่แล้ว

การสั่นของเครื่องมือวัดอาจเป็นประโยชน์ เช่น ในสภาพแวดล้อมที่มีเสียงดัง การสั่นสั้น ๆ สองครั้งส่งสัญญาณว่าการวัดสำเร็จ การสั่นเป็นเวลานานบ่งบอกถึงการวัดที่ไม่ถูกต้อง

- » กดปุ่ม  เพื่อเรียกดูเมนูการตั้งค่าพื้นฐานต่างๆ 
- » เลือก 
- » กดปุ่ม ► หรือปุ่ม ◀ เพื่อเปลี่ยนการเลือก
- » ยืนยันการเลือก โดยกดปุ่ม ▲ หรือปุ่ม Func
- » กดปุ่ม ⏪ แล้วปล่อยเพื่อออกจากเมนูการตั้งค่าพื้นฐานต่างๆ   
เมื่อปิดสวิตช์เครื่องมือวัดค่าที่เลือกจะยังคงถูกเก็บไว้









## การตั้งค่าความสว่างหน้าจอ

สามารถปรับความสว่างของจอแสดงผลให้เข้ากับสภาพแวดล้อมได้หลายระดับ

- » กดปุ่ม  เพื่อเรียกดูเมนูการตั้งค่าพื้นฐานต่างๆ 
- » เลือก 
- » กดปุ่ม  หรือปุ่ม  เพื่อเปลี่ยนการเลือก
- » ยืนยันการเลือก โดยกดปุ่ม  หรือปุ่ม 
- » กดปุ่ม  แล้วปล่อยเพื่อออกจากเมนูการตั้งค่าพื้นฐานต่างๆ   
เมื่อปิดสวิตช์เครื่องมือวัดค่าที่เลือกจะยังคงถูกเก็บไว้

## การเปิด/ปิดใช้งานโหมดประหยัดแบตเตอรี่









ในการตั้งค่าพื้นฐาน โหมดประหยัดแบตเตอรี่จะปิดใช้งานอยู่ เมื่อเปิดใช้งานโหมดประหยัดแบตเตอรี่ เสียงและการสั่นจะปิดใช้งานและความสว่างของจอแสดงผลจะลดลง ซึ่งช่วยขยายอายุการใช้งานแบตเตอรี่

- » กดปุ่ม  เพื่อเรียกดูเมนูการตั้งค่าพื้นฐานต่างๆ 
- » เลือก 
- » กดปุ่ม  หรือปุ่ม  เพื่อเปลี่ยนการเลือก
- » ยืนยันการเลือก โดยกดปุ่ม  หรือปุ่ม 
- » กดปุ่ม  แล้วปล่อยเพื่อออกจากเมนูการตั้งค่าพื้นฐานต่างๆ   
เมื่อปิดสวิตช์เครื่องมือวัดค่าที่เลือกจะยังคงถูกเก็บไว้

## การเปลี่ยนหน่วยของการวัด

หน่วยวัดที่เป็นการตั้งค่าพื้นฐานคือ "ม." (เมตร) มีหน่วยวัดที่แตกต่างกันหกหน่วย ปรับหน่วยวัดให้เหมาะสมกับวัตถุประสงค์ของคุณ











- » กดปุ่ม  เพื่อเรียกดูเมนูการตั้งค่าพื้นฐานต่างๆ 

- » เลือก 
- » กดปุ่ม  หรือปุ่ม  เพื่อเปลี่ยนการเลือก
- » ยืนยันการเลือก โดยกดปุ่ม  หรือปุ่ม 
- » กดปุ่ม  แล้วปล่อยเพื่อออกจากเมนูการตั้งค่าพื้นฐานต่างๆ    
เมื่อปิดสวิตช์เครื่องมือวัดค่าที่เลือกจะยังคงถูกเก็บไว้

### การกำหนดภาษา







เมื่อคุณเปิดเครื่องมือวัดเป็นครั้งแรก คุณจะได้รับแจ้งให้ตั้งค่าภาษาที่คุณต้องการสำหรับข้อความบนหน้าจอแสดงผล

คุณสามารถเปลี่ยนภาษาที่ตั้งไว้ได้ทุกเมื่อ

- » กดปุ่ม  เพื่อเรียกดูเมนูการตั้งค่าพื้นฐานต่างๆ 
- » เลือก  สำหรับการตั้งค่าอื่นๆ เพิ่มเติม
- » เลือก 
- » กดปุ่ม  หรือปุ่ม  เพื่อเปลี่ยนการเลือก
- » ยืนยันการเลือก โดยกดปุ่ม  หรือปุ่ม 
- » กดปุ่ม  แล้วปล่อยเพื่อออกจากเมนูการตั้งค่าพื้นฐานต่างๆ   
เมื่อปิดสวิตช์เครื่องมือวัดค่าที่เลือกจะยังคงถูกเก็บไว้

### ข้อมูลอุปกรณ์









ที่นี่คุณจะทราบข้อมูลเกี่ยวกับเครื่องมือวัด เช่น หมายเลขซีเรียลและเวอร์ชันซอฟต์แวร์และใบอนุญาต

- » กดปุ่ม  เพื่อเรียกดูเมนูการตั้งค่าพื้นฐานต่างๆ 
- » เลือก  สำหรับการตั้งค่าอื่นๆ เพิ่มเติม
- » เลือก 
- » กดปุ่ม  แล้วปล่อยเพื่อออกจากเมนูการตั้งค่าพื้นฐานต่างๆ 











## การตั้งค่าจากโรงงานผลิต

ฟังก์ชันนี้ใช้เพื่อรีเซ็ตเครื่องมือวัดกลับเป็นการตั้งค่าจากโรงงานผลิต/การตั้งค่าพื้นฐาน หลังจากรีเซ็ตคุณจะได้รับแจ้งให้ตั้งค่าภาษาที่คุณต้องการสำหรับข้อความบนหน้าจอแสดงผล

- » กดปุ่ม  เพื่อเรียกดูเมนูการตั้งค่าพื้นฐานต่างๆ 
- » เลือก  สำหรับการตั้งค่าอื่นๆ เพิ่มเติม
- » เลือก 
- » เลือก  แล้วยืนยันโดยใช้ปุ่ม  หรือปุ่ม  เพื่อรีเซ็ตเครื่องมือวัด
- » กดปุ่ม  แล้วปล่อยเพื่อออกจากเมนูการตั้งค่าพื้นฐานต่างๆ 



## การลบหน่วยความจำ









- » กดปุ่ม  เพื่อเรียกดูเมนูการตั้งค่าพื้นฐานต่างๆ 
  - » เลือก  สำหรับการตั้งค่าอื่นๆ เพิ่มเติม
  - » เลือก 
  - » เลือก  โดยใช้ปุ่ม  หรือปุ่ม  แล้วยืนยันโดยใช้ปุ่ม  หรือปุ่ม  เพื่อลบหน่วยความจำ
- ค่าที่วัดได้ทั้งหมดจะถูกลบ

## ฟังก์ชันการวัด

### การเลือก/เปลี่ยนฟังก์ชันการวัดต่างๆ

ในเมนูฟังก์ชันคุณจะพบฟังก์ชันต่างๆ ต่อไปนี้:

-  การวัดความยาว
-  การวัดต่อเนื่อง
- การวัดพื้นที่
- การวัดปริมาตร

-  การวัดระยะทางทางอ้อม
  -  การวัดความสูงทางอ้อม
  -  การวัดความสูงทางอ้อมสองครั้ง
  -  การวัดความยาวทางอ้อม
-  การวัดพื้นผิวผนัง
-  ฟังก์ชันการกำหนดเขต
-  การวัดความลาดชัน/ระดับน้ำดิจิตอล
-  ฟังก์ชันหน่วยความจำ

» กดปุ่ม **Func** เพื่อเปิดเมนู **ฟังก์ชันต่างๆ**

» เลือกการวัดที่ต้องการด้วยปุ่ม **▶** หรือปุ่ม **◀**

» ยืนยันการเลือก โดยกดปุ่ม **Func** หรือปุ่ม **▲**

## ฟังก์ชันช่วยเหลือในระบบ ?

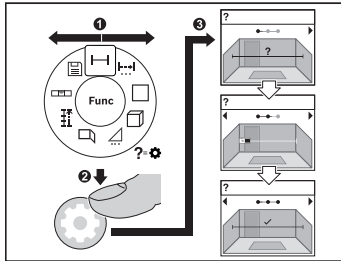

ฟังก์ชันช่วยเหลือที่รวมอยู่ในเครื่องมือวัดมาพร้อมภาพเคลื่อนไหวแสดงฟังก์ชันวัด/กระบวนการวัดทั้งหมด

» เปิดเมนู **ฟังก์ชันต่างๆ**

» เลือกฟังก์ชันที่ต้องการด้วยปุ่ม **▶** หรือปุ่ม **◀** และกดปุ่ม **⚙**

ภาพเคลื่อนไหวพร้อมขั้นตอนดำเนินการโดยละเอียดเกี่ยวกับฟังก์ชันวัดที่เลือกจะ

### ปรากฏขึ้น

» กดปุ่ม **▶** หรือ **◀** เพื่อให้ระบบแสดงขั้นตอนถัดไปหรือก่อนหน้า

## การวัดความยาว —

- » กดปุ่ม **Func** เพื่อเปิดเมนู **ฟังก์ชันต่างๆ**
- » เลือกการวัดความยาว — และยืนยันการเลือกด้วยปุ่ม **Func**
- » กดปุ่ม **▲** เพื่อเปิดเลเซอร์
- » กดปุ่ม **▲** เพื่อเรียกการวัด

ค่าที่วัดได้จะแสดงในบรรทัดผลลัพธ์ด้านล่างในจอแสดงผล (e)

- » สำหรับการวัดเพิ่มเติมแต่ละครั้ง ให้ทำซ้ำขั้นตอนข้างต้น

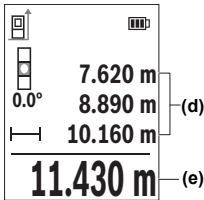

ในกรณีของการวัดความยาวหลายครั้งต่อเนื่องกัน ผลลัพธ์ของการวัดล่าสุดจะแสดงในบรรทัดค่าที่วัดได้ (d) ค่าจากการวัดครั้งล่าสุดแสดงที่ด้านล่างของจอแสดงผล ค่าจากการวัดก่อนครั้งล่าสุดแสดงที่ด้านบน ฯลฯ

## การวัดพื้นที่

- » กดปุ่ม **Func** เพื่อเปิดเมนู **ฟังก์ชันต่างๆ**
- » เลือกการวัดพื้นที่  และยืนยันการเลือกด้วยปุ่ม **Func**
- » กดปุ่ม **▲** เพื่อเปิดเลเซอร์
- » กดปุ่ม **▲** เพื่อเรียกการวัดครั้งแรก เช่น ความยาวของห้อง
- » กดปุ่ม **▲** เพื่อเรียกการวัดครั้งที่สอง เช่น ความกว้างของห้อง

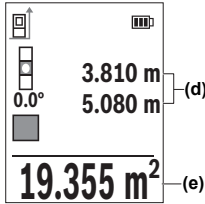

เมื่อการวัดค่าที่สองเสร็จสมบูรณ์ พื้นที่ผิว จะถูกคำนวณโดยอัตโนมัติและแสดงผล ผลลัพธ์จะปรากฏใน บรรทัดผลลัพธ์ (e) ค่าที่วัดได้แต่ละรายการจะอยู่ในบรรทัด ค่าที่วัดได้ (d)

### การวัดต่อเนื่อง

ในกรณีของการวัดอย่างต่อเนื่อง ค่าที่วัดได้จะได้รับการอัปเดตอย่างต่อเนื่อง ต. ย. เช่น ท่านสามารถเดินออกจากผนังไปยังระยะห่างที่ต้องการในขณะที่สามารถอ่านระยะทางจริง ได้เสมอ

การวัดอย่างต่อเนื่องมีฟังก์ชันที่สามารถใช้งานได้สามฟังก์ชัน โดยที่การวัดในแต่ละฟังก์ชัน จะแสดงภาพประกอบแตกต่างกันไป:

### ค่าต่ำสุด/ค่าสูงสุด <sup>min</sup>/<sub>max</sub>

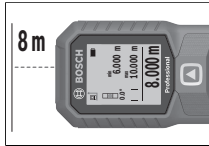

ค่าที่วัดได้ต่ำสุดและสูงสุดจะปรากฏบนจอแสดงผลอย่างต่อเนื่อง

» กดปุ่ม เพื่อเปิดเมนู **ฟังก์ชันต่างๆ**

» เลือกค่าต่ำสุด/ค่าสูงสุด <sup>min</sup>/<sub>max</sub> ในรายการเมนูการวัดอย่างต่อเนื่อง

เนื่อง แล้วยืนยันตัวเลือกโดยใช้ปุ่ม

» กดปุ่ม เพื่อเปิดเลเซอร์

» เลื่อนเครื่องมือวัดจนกระทั่งที่ต้องการแสดงที่ด้านล่างบรรทัดผลลัพธ์

คุณสามารถจัดจังหวะการวัดอย่างต่อเนื่องได้โดยกดปุ่ม

» กดปุ่ม อีกครั้ง เพื่อดำเนินการวัดอย่างต่อเนื่อง

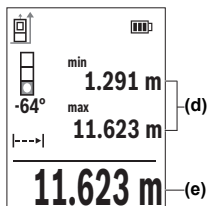

ค่าที่วัดได้ในปัจจุบันจะแสดงในบรรทัดผลลัพธ์ (e) ค่าสูงสุด และค่าต่ำสุดที่วัดได้ในบรรทัดค่าที่วัดได้ (d)

### ตัวเลขขนาดใหญ่ 00<sup>+</sup>

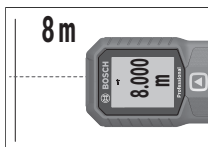

ค่าที่วัดได้จะแสดงแบบขยายใหญ่ขึ้นเพื่อให้อ่านได้ชัดเจนยิ่งขึ้น

### แถบวัด

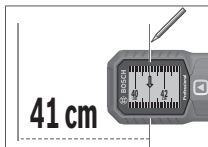





ระยะห่างจะแสดงผลแบบเสมือนจริงในรูปแบบแถบวัด

 ในฟังก์ชันแถบวัด ระบุอ้างอิงคือเครื่องหมายที่ปรากฏบนจอแสดงผล ระบุอ้างอิงไม่ใช่ขอบของเครื่องมือวัด

การวัดต่อเนื่องจะปิดสวิตช์โดยอัตโนมัติหลังจากผ่านไป 4 นาที

### การวัดปริมาตร

- » กดปุ่ม  เพื่อเปิดเมนู ฟังก์ชันต่างๆ
- » เลือกการวัดปริมาตร  และยืนยันการเลือกด้วยปุ่ม 
- » กดปุ่ม  เพื่อเปิดเลเซอร์

- » กดปุ่ม ▲ เพื่อเรียกการวัดครั้งแรก เช่น ความยาวของห้อง
- » กดปุ่ม ▲ เพื่อเรียกการวัดครั้งที่สอง เช่น ความกว้างของห้อง
- » กดปุ่ม ▲ เพื่อเรียกการวัดครั้งที่สาม เช่น ความสูงของห้อง

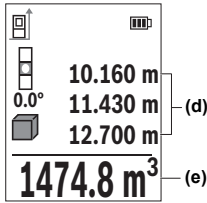

เมื่อการวัดค่าที่สามเสร็จสมบูรณ์ ปริมาตรจะถูกคำนวณโดยอัตโนมัติและแสดงผล ผลลัพธ์จะปรากฏในบรรทัดผลลัพธ์ (e) ค่าที่วัดได้แต่ละรายการจะอยู่ในบรรทัดค่าที่วัดได้ (d)

### การวัดระยะทางทางอ้อม



การวัดระยะทางทางอ้อมใช้วัดระยะทางที่ไม่สามารถวัดได้โดยตรง เพราะมีสิ่งกีดขวางที่อาจขวางลำแสงเลเซอร์หรือไม่มีผิวเป้าหมายที่เป็นตัวสะท้อนแสง กระบวนการวัดนี้สามารถใช้ได้เฉพาะในทิศทางแนวตั้งเท่านั้น การเขียนแบบใดๆ ในแนวนอนนำไปสู่ความผิดพลาดในการวัด

การวัดระยะทางทางอ้อมจะแม่นยำน้อยกว่าการวัดระยะทางทางตรงเสมอ ข้อผิดพลาดในการวัดอาจมีมากกว่าการวัดระยะทางตรงทั้งนี้ขึ้นอยู่กับการใช้งาน เพื่อปรับปรุงความแม่นยำการวัด แนะนำให้ใช้ขาตั้งแบบสามขา (อุปกรณ์ประกอบ)

 เมื่อใช้ขาตั้งกล้อง ให้สังเกตระนาบอ้างอิงที่ตั้งไว้ (ดู "เลือกระนาบอ้างอิง", หน้า 156)

ระหว่างการวัดแต่ละครั้งลำแสงเลเซอร์ยังคงเปิดอยู่

สำหรับการวัดความยาวทางอ้อม มี 3 ฟังก์ชันการวัดต่างๆ แต่ละฟังก์ชันการวัดสามารถให้หาระยะที่แตกต่างกัน:

-  การวัดความสูงทางอ้อม
-  การวัดความสูงทางอ้อมสองครั้ง
-  การวัดความยาวทางอ้อม

## การวัดความสูงทางอ้อม

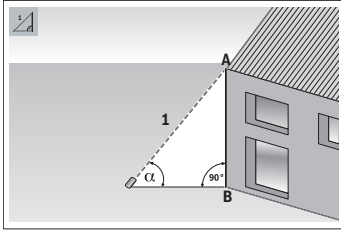

ด้วยการวัดความสูงทางอ้อม คุณสามารถกำหนดระยะห่าง **AB** ได้โดยการวัดระยะห่าง **1** เครื่องมือวัดจะคำนวณความสูง **AB** จากมุม  $\alpha$  และระยะห่าง **1** จะได้ผลลัพธ์ที่ถูกต้องต่อเมื่อยึดมุมฉากที่จำเป็นสำหรับการวัดที่เกี่ยวข้องอย่างแม่นยำเท่านั้น

- » กดปุ่ม **Func** เพื่อเปิดเมนู **ฟังก์ชันต่างๆ**
- » เลือกการวัดระยะห่างโดยอ้อม และยืนยันการเลือกด้วยปุ่ม **Func**
- » เลือกการวัดความสูงโดยอ้อม และยืนยันการเลือกด้วยปุ่ม **Func**
- » กดปุ่ม **▲** เพื่อเปิดเลเซอร์
- » วางเครื่องมือวัดที่ระดับจุดวัดด้านล่าง **B**
- » เอียงเครื่องมือวัดเพื่อให้เลเซอร์มุ่งไปที่จุดวัดด้านบน **A**
- » กดปุ่ม **▲** เพื่อเรียกการวัด

เมื่อการวัดค่าทั้งสองเสร็จสมบูรณ์ ความสูงจะถูกคำนวณโดยอัตโนมัติและแสดงผลในหน่วยบรรทัดผลลัพธ์ **(e)** ค่าจากการวัดสำหรับระยะทาง **1** และมุม  $\alpha$  จะแสดงในบรรทัดแสดงค่าจากการวัด **(d)**

### การวัดความสูงทางอ้อมสองครั้ง ◁

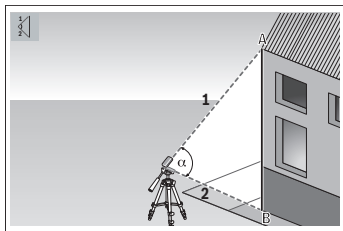

ด้วยการวัดความสูงทางอ้อมสองครั้ง คุณสามารถกำหนดระยะห่าง **AB** ได้โดยการวัดระยะห่าง **1** และ **2** เครื่องมือวัดจะคำนวณความสูง **AB** จากมุม  $\alpha$  และระยะห่าง **1** และ **2**  
สำหรับการวัดนี้ เราขอแนะนำให้ใช้ขาตั้งแบบสามขา

» กดปุ่ม **Func** เพื่อเปิดเมนู **ฟังก์ชันต่างๆ**

» เลือกการวัดระยะห่างโดยอ้อม ◁ และยืนยันการเลือกด้วยปุ่ม **Func**

» เลือกการวัดความสูงโดยอ้อมสองรอบ ◁ และยืนยันการเลือกด้วยปุ่ม **Func**

» กดปุ่ม **▲** เพื่อเปิดเลเซอร์

» เอียงเครื่องมือวัดเพื่อให้เลเซอร์มุ่งไปที่จุดวัดด้านบน **A**

» กดปุ่ม **▲**, เพื่อเรียกการวัดครั้งแรก

» เอียงเครื่องมือวัดเพื่อให้เลเซอร์มุ่งไปที่จุดวัดด้านล่าง **B** กรุณาอย่าเปลี่ยนตำแหน่งเครื่องมือวัด

» กดปุ่ม **▲** เพื่อเรียกการวัดครั้งที่สอง

เมื่อการวัดค่าที่สองเสร็จสมบูรณ์ ความสูงจะถูกคำนวณโดยอัตโนมัติและแสดงผลในในบรรทัดผลลัพธ์ (e) ค่าจากการวัดสำหรับระยะทาง **1, 2** และมุม  $\alpha$  จะแสดงในบรรทัดแสดงค่าจากการวัด (d)

### การวัดความยาวทางอ้อม ◁

» กดปุ่ม **Func** เพื่อเปิดเมนู **ฟังก์ชันต่างๆ**

» เลือกการวัดระยะห่างโดยอ้อม ◁ และยืนยันการเลือกด้วยปุ่ม **Func**



- » เลือกการวัดความยาวโดยอ้อม  และยืนยันการเลือกด้วยปุ่ม **Func**
- » วางเครื่องมือวัดบนจุดเริ่มต้น **A** ของระยะห่างที่เลือก **AB**
- » เอียงเครื่องมือวัดเพื่อให้เลเซอร์มุ่งไปที่ระดับที่อยู่ ณ จุดสิ้นสุด **B**
- » กดปุ่ม **▲** เพื่อเรียกการวัด

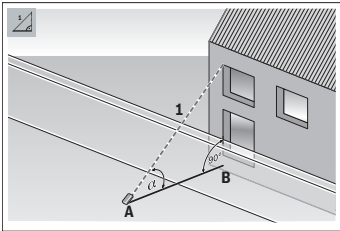

ด้วยการวัดความยาวทางอ้อม คุณสามารถกำหนดระยะห่าง **AB** ได้โดยการวัดระยะห่าง **1** เครื่องมือวัดจะคำนวณความยาวที่เลือก **AB** จากมุม  $\alpha$  และระยะห่าง **1**

เมื่อการวัดค่าที่สองเสร็จสมบูรณ์ ความยาวจะถูกคำนวณโดยอัตโนมัติและแสดงผลในใบบรรทัดผลลัพธ์ **(e)** ค่าจากการวัดสำหรับระยะห่าง **1** และมุม  $\alpha$  จะแสดงในบรรทัดแสดงค่าจากการวัด **(d)**

### การวัดพื้นผิวผนัง

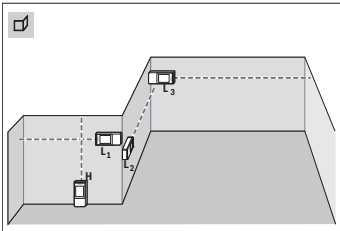

การวัดพื้นผิวผนังใช้สำหรับคำนวณผลรวมของพื้นผิวแต่ละด้านหลายๆ พื้นผิวที่มีความสูงเท่ากัน เจ็อนไซเมื่องต้นสำหรับการคำนวณพื้นที่อย่างถูกต้องคือความยาวที่วัดครั้งแรก (ในตัวอย่างคือความสูงห้อง **H**) ต้องเท่ากันในทุกๆ ด้าน ในตัวอย่างที่แสดงเราต้องการหาพื้นผิวทั้งหมดของผนังหลายด้านที่มีความสูงห้อง **H** เท่ากัน แต่ความยาว

**L** ต่างกัน

- » กดปุ่ม **Func** เพื่อเปิดเมนู **ฟังก์ชันต่างๆ**

- » เลือกการวัดพื้นผิวผนัง  และยืนยันการเลือกด้วยปุ่ม **Func**
- » วัดความสูงห้อง **H** ในลักษณะเดียวกับการวัดความยาว  
ค่าจากการวัดแสดงในบรรทัดบนของบรรทัดแสดงค่าจากการวัด เลเซอร์ยังคงเปิดอยู่
- » จากนั้นให้วัดความยาว **L1** ของผนังแรก  
พื้นที่ผิวจะถูกคำนวณโดยอัตโนมัติและแสดงในบรรทัดผลลัพธ์ ค่าความยาวจากการวัด  
ครั้งล่าสุดแสดงในบรรทัดล่างของบรรทัดแสดงค่าจากการวัด เลเซอร์ยังคงเปิดอยู่
- » ต่อไปให้วัดความยาว **L2** ของผนังที่สอง

คุณสามารถวัดความยาว **LX** อื่นๆ อีกมากมาย ซึ่งความยาวจะถูกนำมารวมกันโดยอัตโนมัติ  
แล้วนำมาคูณกับความสูง **H**

ค่าการวัดแต่ละครั้งที่แสดงในบรรทัดแสดงค่าจากการวัด (**d**) จะรวมกับความยาว **L1** ผล  
รวมของความยาวทั้งสอง (แสดงในบรรทัดกลางของบรรทัดแสดงค่าจากการวัด (**d**)) จะ  
คูณกับความสูงที่เก็บไว้ **H** ค่าพื้นผิวทั้งหมดจะแสดงในบรรทัดผลลัพธ์ (**e**) ด้านล่างในหน้า  
จอแสดงผล

### ฟังก์ชันการกำหนดเขต

- i** ในฟังก์ชันการกำหนดเขต ระบุบางอย่างคือเครื่องหมายที่แสดงในจอแสดงผล  
ระบุบางอย่างไม่ใช่ขอบของเครื่องมือวัด

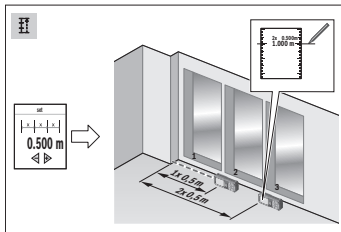

ฟังก์ชันการกำหนดเขตจะวัดความยาวที่กำหนดไว้แล้ว (ระยะทาง) ความยาวนี้สามารถถ่ายทอดลงบนพื้นผิว ต. ย. เช่น เพื่อจะได้ตัดวัสดุให้มีความยาวเท่าๆ กัน หรือติดตั้งผนังระบบโครงคร่าวในตรายอลล์ ความยาวต่ำสุดที่สามารถปรับได้คือ 0.1 ม. ความยาวสูงสุดคือ 50 ม.

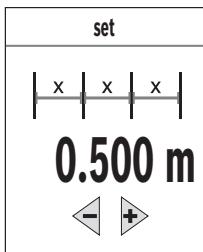

- » กดปุ่ม **Func** เพื่อเปิดเมนู ฟังก์ชันต่างๆ
- » เลือกฟังก์ชันการกำหนดเขต **III** และยืนยันการเลือกด้วยปุ่ม **Func**
- » ตั้งค่าความยาวที่ต้องการด้วยปุ่ม **▶** หรือปุ่ม **◀** กดปุ่ม **▶** หรือปุ่ม **◀** ค้างไว้ เพื่อเปลี่ยนความยาวเพิ่มขึ้น
- » กดปุ่ม **▲** เพื่อเริ่มต้นฟังก์ชันการกำหนดเขตและถอยออกจากจุดเริ่มต้นอย่างช้าๆ

เครื่องมือวัดจะวัดระยะทางจากจุดเริ่มต้นอย่างต่อเนื่อง ความยาวที่กำหนดไว้รวมทั้งค่าจากการวัดปัจจุบันจะปรากฏขึ้น ลูกศรบนและล่างแสดงให้เห็นระยะทางที่สั้นที่สุดไปยังเครื่องหมายถัดไปหรือก่อนหน้า



ตัวคูณทางด้านซ้ายระบุจำนวนครั้งที่ถึงความยาวที่กำหนดแล้ว เส้นสีเขียวด้านข้างบนจอแสดงผลจะแสดงความยาวที่ช่วยให้บรรลุวัตถุประสงค์ในการวัด



เส้นสีน้ำเงินและข้อความสีน้ำเงินจะแสดงค่าจริง หากค่าอ้างอิงอยู่นอกจอแสดงผล

## การวัดความลาดชัน/ระดับน้ำดิจิตอล

ระดับน้ำดิจิตอลใช้สำหรับตรวจสอบการปรับระนาบแนวอนหรือแนวตั้งของสิ่งของ (ต. ย. เช่น เครื่องซักผ้า ตู้เย็น ฯลฯ) การวัดความลาดชันใช้สำหรับวัดความเอียงหรือความชัน (ต. ย. เช่น ขอบบันได ราวบันได สำหรับปรับเฟอร์นิเจอร์ให้เหมาะสม สำหรับติดตั้งท่อ ฯลฯ) เครื่องมือวัดจะสลับระหว่างฟังก์ชันต่างๆ โดยอัตโนมัติเมื่อคุณเปลี่ยนตำแหน่งเครื่องมือวัด

» กดปุ่ม  เพื่อเปิดเมนู **ฟังก์ชันต่างๆ**

» เลือกการวัดความเอียง/ระดับน้ำดิจิตอล  และยืนยันการเลือกด้วยปุ่ม 

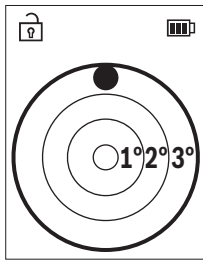

สำหรับระดับน้ำดิจิตอล ให้ใช้ด้านซ้ายของเครื่องมือวัดเป็น  
ระนาบอ้างอิง

» ในการใช้ระดับน้ำแบบดิจิตอล ให้วางเครื่องมือวัดโดยให้  
หลังเครื่องมืออยู่บนพื้นผิวที่จะวัด

คุณสามารถหยุดการอ่านได้โดยกดปุ่ม 

» ถ้ามีความลาดชันเกินกว่า 3° ลูกกลมบนจอแสดงผลจะ  
ส่องสว่างสีแดง

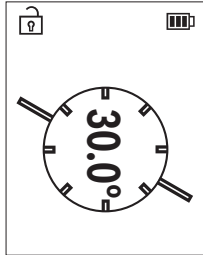

สำหรับการวัดความลาดชัน ให้ใช้ด้านซ้ายของเครื่องมือวัดเป็น  
ระนาบอ้างอิง หากสัญลักษณ์กะพริบในระหว่างกระบวนการวัด  
แสดงว่าเครื่องมือวัดเอียงไปทางด้านข้างมากเกินไป

» ในการใช้การวัดความเอียง ให้วางเครื่องมือวัดที่มีพื้นผิว  
ด้านหนึ่งบนวัตถุที่คุณต้องการวัดความเอียง





คุณสามารถหยุดการอ่านได้โดยกดปุ่ม 

## ฟังก์ชันหน่วยความจำ

ค่าและผลลัพธ์สุดท้ายของการวัดแต่ละครั้งที่เสร็จสมบูรณ์จะถูกบันทึกไว้โดยอัตโนมัติ **30**

ค่าสุดท้าย (ค่าที่วัดหรือผลลัพธ์สุดท้าย) จะถูกบันทึกไว้ หากหน่วยความจำเต็ม ค่าที่เก่า

ที่สุดจะถูกเขียนทับ ค่าเก่าที่สุดจะอยู่ที่ตำแหน่งที่ 1 ในหน่วยความจำ ค่าล่าสุดอยู่ในตำแหน่ง 30 (สำหรับค่าในหน่วยความจำ 30 ค่าที่มีอยู่)

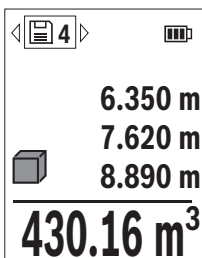

- » กดปุ่ม  เพื่อเปิดเมนู **ฟังก์ชันต่างๆ**
- » เลือกฟังก์ชันหน่วยความจำ  แล้วยืนยันตัวเลือกโดยใช้ปุ่ม   
ค่าสุดท้ายจะปรากฏขึ้น
- » กดปุ่ม  หรือปุ่ม  เพื่อเลื่อนดูค่าที่บันทึกไว้



จำนวนของค่าหน่วยความจำจะปรากฏที่ด้านบนของจอแสดงผล ค่าหน่วยความจำที่สอดคล้องกันและสัญลักษณ์ของฟังก์ชันการวัดที่เกี่ยวข้องจะปรากฏทางด้านซ้าย หากไม่มีค่าในหน่วยความจำ "0.000" และจะแสดงในบรรทัดล่างของจอแสดงผลผล "0" ในบรรทัดบน

### ลบค่าหน่วยความจำ

- » กดปุ่ม  เพื่อลบค่าที่แสดง
- » ยืนยันด้วยปุ่ม 

หากต้องการลบค่าที่เก็บไว้ทั้งหมด ให้เลือกในเมนู **การตั้งค่าพื้นฐานต่างๆ**  รายการเมนู **ลบหน่วยความจำ** (ดู "การลบหน่วยความจำ " , หน้า 161)



### การเพิ่ม/การลดค่า

#### เพิ่มค่าเมื่อวัดความยาว

- » เลือกฟังก์ชันการวัดความยาว

- » ดำเนินการวัดครั้งแรก
- » กดปุ่ม 
- » ดำเนินการวัดครั้งที่สอง  
ทันทีที่การวัดครั้งที่สองเสร็จสิ้น ผลลัพธ์ของการวัดที่สองจะแสดงในบรรทัดค่าที่วัดได้ (d) และผลลัพธ์สุดท้ายในบรรทัดผลลัพธ์ (e)



### เพิ่มค่าเมื่อวัดพื้นที่และปริมาตร

- » เลือกฟังก์ชันการวัดพื้นที่และการวัดปริมาตร
- » ดำเนินการวัดพื้นที่และการวัดปริมาตรครั้งแรก
- » กดปุ่ม 
- » ดำเนินการวัดพื้นที่และการวัดปริมาตรครั้งที่สอง  
ทันทีที่การวัดครั้งที่สองหรือสามเสร็จสิ้น พื้นที่หรือปริมาตรจะถูกคำนวณและแสดงผลโดยอัตโนมัติ ผลลัพธ์จะปรากฏในบรรทัดผลลัพธ์ (e) ค่าที่วัดได้แต่ละรายการจะอยู่ในบรรทัดค่าที่วัดได้ (d)
- » กดปุ่ม  เพื่อดูผลลัพธ์ของการเพิ่ม  
ผลลัพธ์สุดท้ายจะปรากฏในบรรทัดผลลัพธ์ (e) ผลลัพธ์ของการวัดแต่ละพื้นที่หรือปริมาตรจะแสดงในบรรทัดค่าที่วัดได้ (d)

### การลดค่า

- » เมื่อต้องการลดค่าให้กดปุ่ม  ขั้นตอนต่อไปจะเหมือนกับ "การเพิ่มค่า"

### ลบค่าที่วัดได้

คุณสามารถลบค่าที่วัดล่าสุดในการวัดทั้งหมดออกได้โดยกดปุ่ม   ซ้ำๆ กัน จะลบทั้งค่าจากการวัดในลำดับย้อนกลับ

## Bluetooth®-อินเตอร์เฟส

### การถ่ายทอข้อมูลไปยังอุปกรณ์อื่นๆ

เครื่องมือวัดนี้ติดตั้งโมดูล Bluetooth® ที่ช่วยถ่ายทอข้อมูลด้วยเทคโนโลยีคลื่นวิทยุสำหรับเชื่อมโยงสื่อสารแบบไร้สายไปยังอุปกรณ์เคลื่อนที่ปลายทางบางอย่างที่มี Bluetooth® (เช่น สมาร์ทโฟน แท็บเล็ต)

กรุณาค้นหาข้อมูลเกี่ยวกับความต้องการของระบบที่จำเป็นสำหรับการเชื่อมต่อ Bluetooth® ได้ที่เว็บไซต์ของ บอช [www.bosch-pt.com](http://www.bosch-pt.com)

### ► สำหรับข้อมูลเพิ่มเติม กรุณาดูหน้าผลิตภัณฑ์ของ บอช

ในระหว่างการถ่ายทอข้อมูลผ่านทาง Bluetooth® อาจเกิดความล่าช้าในการแปรสัญญาณระหว่างอุปกรณ์เคลื่อนที่ปลายทางและเครื่องมือวัด ทั้งนี้ขึ้นอยู่กับระยะห่างระหว่างอุปกรณ์ที่สื่อสารข้อมูลหรือวัตถุที่จะวัด

### การเรียกใช้งาน Bluetooth®-อินเตอร์เฟสเพื่อถ่ายทอข้อมูลไปยังอุปกรณ์เคลื่อนที่ปลายทาง

✓ ตรวจสอบให้แน่ใจว่า อินเตอร์เฟส Bluetooth® ที่อุปกรณ์เคลื่อนที่ปลายทางของท่าน ถูกเรียกใช้งาน

- » กดปุ่ม  เพื่อเรียกดูเมนู Bluetooth®
- » กดปุ่ม  อีกครั้งเพื่อเปิดใช้งานอินเตอร์เฟส Bluetooth®

(b) สถานะการเชื่อมต่อและการเชื่อมต่อที่ใช้งานอยู่ (b) จะปรากฏบนจอแสดงผล (h) ของเครื่องมือวัด

(h) 

Bosch-Apps พร้อมใช้งานเพื่อขยายขอบเขตการทำงาน คุณสามารถดาวน์โหลดได้จาก App Stores ทั้งนี้ขึ้นอยู่กับอุปกรณ์

เมื่อเริ่มต้น Bosch แอปพลิเคชัน การเชื่อมต่อระหว่างอุปกรณ์เคลื่อนที่ปลายทางและเครื่องมือวัดจะเกิดขึ้น ถ้าพบเครื่องมือวัดที่ทำงานอยู่หลายเครื่อง ให้เลือกเครื่องมือวัดที่เหมาะสมโดย

ดูจากหมายเลขเครื่อง ท่านสามารถค้นหาหมายเลขเครื่อง (11) จากแผ่นป้ายรุ่นของเครื่องมือวัดของท่าน

### การปิดการเรียกใช้งาน Bluetooth®-อินเตอร์เฟส



- » กดปุ่ม  เพื่อเรียกดูเมนู Bluetooth® แล้วกดปุ่ม  อีกครั้งเพื่อปิดใช้งานอินเตอร์เฟส Bluetooth®

### การตรวจสอบความแม่นยำ

ตรวจสอบความแม่นยำของการวัดความลาดชันและการวัดระยะทางเป็นประจำ

#### การตรวจสอบความแม่นยำและการสอบเทียบของการวัดความลาดชัน

- » สำหรับการตรวจสอบ ให้วางเครื่องมือวัดบนโต๊ะและวัดความลาดชัน
  - » หมุนเครื่องมือวัดไป 180° และวัดความลาดชันอีกครั้งหนึ่ง
- ความแตกต่างของจำนวนเลขที่แสดงต้องไม่มากกว่า 0.3° (สูงสุด)
- ในกรณีที่มีส่วนเบี่ยงเบนมากกว่า จะต้องสอบเทียบเครื่องมือวัดใหม่

- » กดปุ่ม  เพื่อเปิดเมนูการตั้งค่าพื้นฐานต่างๆ
- » เลือก  และยืนยันการเลือกด้วยปุ่ม 
- » ทำตามคำแนะนำบนจอแสดงผล

**i** เมื่ออุณหภูมิมีการเปลี่ยนแปลงมากและเครื่องมือวัดถูกกระทบ เราขอแนะนำให้ตรวจสอบความแม่นยำ และหากจำเป็นให้สอบเทียบเครื่องมือวัด เมื่ออุณหภูมิมีการเปลี่ยนแปลงมาก ต้องปล่อยให้เครื่องมือวัดปรับเข้ากับอุณหภูมิรอบด้านสักชั่วครู่ก่อนสอบเทียบ



## การตรวจสอบความแม่นยำของการวัดระยะทาง

ในการตรวจสอบความแม่นยำ การวัดควรดำเนินการภายใต้สภาวะที่เหมาะสม เช่น ระยะทางวัดควรอยู่ภายใน และพื้นผิวเป้าหมายของการวัดควรเรียบและสะท้อนแสงได้ดี (เช่น ฉันทาสีขาว)

- » เลือกระยะทางวัดประมาณ **3 ถึง 10 เมตร** ซึ่งมีความยาวที่คุณทราบแน่ชัด (เช่น ความกว้างของห้อง ระยะเปิดประตู)
- » วัดระยะทาง **10 ครั้งติดต่อกัน**

ความเบี่ยงเบนของการวัดแต่ละรายการจากขนาดที่ทราบแน่นอนต้องไม่เกิน  $\pm 2$  มม. ตลอดช่วงการวัดทั้งหมดภายใต้สภาวะที่เอื้ออำนวย บันทึกการวัดเพื่อให้คุณสามารถเปรียบเทียบความถูกต้องได้ในภายหลัง

## การทำงานกับขาตั้งแบบสามขา (อุปกรณ์ประกอบ)

การใช้ขาตั้งแบบสามขาช่วยสำหรับการวัดระยะทางไกล

- » วางเครื่องมือวัดที่มีเกลียวขนาด  $1/4$  นิ้ว (**14**) เข้าบนเฟลตยึดแบบเปลี่ยนเร็วของขาตั้งแบบสามขา (**25**) หรือขาตั้งกล้องแบบสามขาทั่วไป
- » ยึดเครื่องมือวัดให้แน่นด้วยสลักรูล้อของเฟลทชนิดเปลี่ยนเร็ว
- » ตั้งระนาบอ้างอิงสำหรับการวัดด้วยขาตั้งแบบสามขา (ดู "เลือกระนาบอ้างอิง", หน้า 156)

## คลิปหนีบเข็มขัด

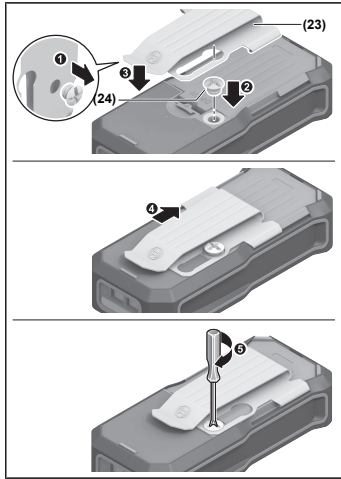

คลิปหนีบเข็มขัด (23) ช่วยให้คุณสามารถห้อยเครื่องมือวัดบนเข็มขัดสายพานได้อย่างง่ายดาย

สำหรับการติดตั้งคลิปหนีบเข็มขัดที่เครื่องมือวัด ให้ปฏิบัติตามขั้นตอนต่างๆ ในภาพประกอบ

## ข้อความแสดงข้อผิดพลาด

หากไม่สามารถทำการวัดได้อย่างถูกต้องจะปรากฏข้อความแสดงข้อผิดพลาด **Error** บนจอแสดงผล

- » ลองทำการวัดอีกครั้ง
- » หากข้อความแสดงข้อผิดพลาดปรากฏขึ้นอีกครั้ง ให้ปิดและเปิดสวิตช์เครื่องมือวัดแล้วเริ่มการวัดอีกครั้ง



เครื่องมือวัดจะตรวจสอบการทำงานที่ถูกต้องของแต่ละการวัด หากพบข้อผิดพลาด จอแสดงผลจะแสดงเฉพาะสัญลักษณ์ที่อยู่ติดกัน และเครื่องมือวัดจะปิดตัวเอง ในกรณีเช่นนี้ ให้ส่งเครื่องมือวัดเข้ารับการตรวจสอบที่ศูนย์บริการหลังการขายสำหรับเครื่องมือไฟฟ้า Bosch ของคุณ

## การบำรุงรักษาและการบริการ

### การบำรุงรักษาและการทำความสะอาด

เก็บรักษาและขนย้ายเครื่องมือวัดเฉพาะเมื่อบรรจุอยู่ในกระเป๋าลู่เครื่องมือวัดที่จัดมาให้เท่านั้น

รักษาเครื่องมือวัดให้สะอาดตลอดเวลา

อย่าจุ่มเครื่องมือวัดลงในน้ำหรือของเหลวอื่นๆ

เช็ดสิ่งสกปรกออกด้วยผ้านุ่มที่เปียกหมาดๆอย่าใช้สารซักฟอกหรือตัวทำละลาย

คู่มือรักษาเลนส์รับแสง (15) เป็นพิเศษเหมือนกับการดูแลรักษาแว่นตาหรือเลนส์กล้องถ่ายภาพ

ในกรณีข้อมแซม ให้ส่งเครื่องมือวัดโดยบรรจุลงในกระเป๋าลู่เครื่องมือวัด (18)

### การบริการหลังการขายและการให้คำปรึกษาการใช้งาน

ศูนย์บริการหลังการขายของเรายินดีตอบคำถามของท่านที่เกี่ยวกับการบำรุงรักษาและการซ่อมแซมผลิตภัณฑ์รวมทั้งเรื่องอะไหล่ ภาพเขียนแบบการประกอบและข้อมูลเกี่ยวกับอะไหล่ กรุณาดูใน: [www.bosch-pt.com](http://www.bosch-pt.com)

ทีมงานที่ปรึกษาของ บอช ยินดีให้ข้อมูลเกี่ยวกับผลิตภัณฑ์ของเราและอุปกรณ์ประกอบต่างๆ

เมื่อต้องการสอบถามและสั่งซื้ออะไหล่ กรุณาแจ้งหมายเลขสินค้า 10 หลักบนแผ่นป้ายรุ่นของผลิตภัณฑ์ทุกครั้ง

### ไทย

ไทย บริษัท โรเบิร์ต บอช จำกัด

เอฟวายไอ เซ็นเตอร์ อาคาร 1 ชั้น 5

เลขที่ 2525 ถนนพระราม 4

แขวงคลองเตย เขตคลองเตย กรุงเทพฯ 10110

โทร: +66 2012 8888

แฟกซ์: +66 2064 5800

www.bosch.co.th

ศูนย์บริการซ่อมและฝึกอบรม บอช

อาคาร ลาซาลทาวเวอร์ ชั้น G ห้องเลขที่ 2

บ้านเลขที่ 10/11 หมู่ 16

ถนนศรีนครินทร์ ตำบลบางแก้ว อำเภอบางพลี

จังหวัดสมุทรปราการ 10540

ประเทศไทย

โทรศัพท์ 02 7587555

โทรสาร 02 7587525

**สามารถดูที่อยู่ศูนย์บริการอื่นๆ ได้ที่:**

[www.bosch-pt.com/serviceaddresses](http://www.bosch-pt.com/serviceaddresses)

## การขนส่ง

แบตเตอรี่ลิเธียมไอออนที่แนะนำให้ใช้ อยู่ภายใต้ข้อกำหนดแห่งกฎหมายสินค้าอันตราย ผู้ใช้สามารถขนส่งแบตเตอรี่แพ็คโดยทางถนนโดยไม่มีข้อบังคับอื่นหากขนส่งโดยบุคคลที่สาม (เช่น : การขนส่งทางอากาศ หรือตัวแทนขนส่งสินค้า) ต้องปฏิบัติตามข้อกำหนดพิเศษเกี่ยวกับการบรรจุภัณฑ์และการติดฉลาก สำหรับการจัดเตรียมสิ่งของที่จัดส่ง จำเป็นต้องปรึกษาผู้เชี่ยวชาญด้านวัตถุอันตราย

ส่งแบตเตอรี่แพ็คเมื่อตัวหุ้มไม่ชำรุดเสียหายเท่านั้น ใช้แถบกาวพันปิดหน้าสัมผัสที่เปิดอยู่ และนำแบตเตอรี่แพ็คใส่กล่องบรรจุโดยไม่ให้เคลื่อนไปมาในกล่องได้ นอกจากนี้ นี้กรุณาปฏิบัติตามกฎระเบียบของประเทศซึ่งอาจมีรายละเอียดเพิ่มเติม

## การกำจัดขยะ



เครื่องมือวัด แบตเตอรี่แพ็ค/แบตเตอรี่ อุปกรณ์ประกอบ และหีบห่อ ต้องนำไปแยกประเภทวัสดุเพื่อนำกลับมาใช้ใหม่โดยไม่ทำลายสภาพแวดล้อม



อย่าทิ้งเครื่องมือวัดและแบตเตอรี่แพ็ค/แบตเตอรี่ลงในขยะบ้าน!

**แบตเตอรี่แพ็ค/แบตเตอรี่:**

**ลิเทียมไอออน:**

กรุณาปฏิบัติตามคำแนะนำในบทการขนส่ง(ดู "การขนส่ง", หน้า 180)

## อุปกรณ์เสริม

คุณสามารถค้นหาอุปกรณ์เสริมได้จากลิงค์ของเว็บไซต์ Bosch



BA 3.7V 1.0Ah A (19)

1 608 M00 C5D

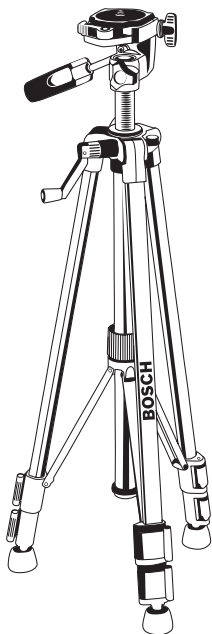

ขาตั้งแบบสามขา BT 150 (25)

0 601 096 B00

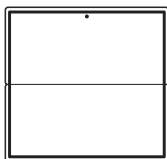

ด้ามจับอเนกประสงค์ (26)

2 607 001 391



แว่นตาสำหรับมองแสงเลเซอร์ (สีเขียว) (27)

1 608 M00 05J

## Bahasa Indonesia

### Petunjuk Keselamatan



Petunjuk lengkap ini harus dibaca dan diperhatikan agar tidak terjadi bahaya dan Anda dapat bekerja dengan aman saat menggunakan alat ukur ini. Apabila alat ukur tidak digunakan sesuai dengan petunjuk yang disertakan, keamanan alat ukur dapat terganggu. Janganlah sekali-

kali menutupi atau melepas label keselamatan kerja yang ada pada alat ukur ini. **SIMPAN PETUNJUK INI DENGAN BAIK DAN BERIKAN KEPADA PEMILIK ALAT UKUR BERIKUTNYA.**

- ▶ **Perhatian** – jika perangkat pengoperasian atau perangkat pengaturan atau prosedur lain selain yang dituliskan di sini digunakan, hal ini dapat menyebabkan terjadinya paparan radiasi yang berbahaya.
- ▶ Alat pengukur dikirim dengan tanda peringatan laser (ditandai dengan ilustrasi alat pengukur di halaman grafis).
- ▶ Jika teks pada tanda peringatan laser tidak tertulis dalam bahasa negara Anda, tempelkan label yang tersedia dalam bahasa negara Anda di atas label berbahasa Inggris sebelum Anda menggunakan alat untuk pertama kalinya.



**Jangan melihat sinar laser ataupun mengarahkannya kepada orang lain atau hewan baik secara langsung maupun dari pantulan.** Sinar laser dapat membutakan seseorang, menyebabkan kecelakaan atau merusak mata.

- ▶ **Jika radiasi laser mengenai mata, tutup mata Anda dan segera gerakan kepala agar tidak terkena sorotan laser.**

- ▶ **Jangan mengubah peralatan laser.**
- ▶ **Perbaiki alat ukur hanya di teknisi ahli resmi dan gunakan hanya suku cadang asli.** Dengan demikian, keselamatan kerja dengan alat ukur ini selalu terjamin.
- ▶ **Jangan biarkan anak-anak menggunakan alat ukur laser tanpa pengawasan.** Hal ini dapat menyilaukan orang lain atau diri sendiri secara tidak sengaja.
- ▶ **Jangan mengoperasikan alat ukur di area yang berpotensi meledak yang di dalamnya terdapat cairan, gas, atau serbuk yang dapat terbakar.** Di dalam alat pengukur dapat terjadi bunga api, yang lalu menyulut debu atau uap.
- ▶ **Jangan membuka baterai.** Ada bahaya terjadinya korsleting.
- ▶ **Asap dapat keluar apabila terjadi kerusakan atau penggunaan yang tidak tepat pada baterai. Baterai dapat terbakar atau meledak.** Biarkan udara segar mengalir masuk dan kunjungi dokter apabila mengalami gangguan kesehatan. Asap tersebut dapat mengganggu saluran pernafasan.
- ▶ **Penggunaan yang salah pada baterai atau baterai yang rusak dapat menyebabkan keluarnya cairan yang mudah terbakar dari baterai. Hindari terkena cairan ini. Jika tanpa sengaja terkena cairan ini, segera bilas dengan air. Jika cairan tersebut terkena mata, segera hubungi dokter untuk pertolongan lebih lanjut.** Cairan yang keluar dari baterai dapat menyebabkan iritasi pada kulit atau luka bakar.
- ▶ **Baterai dapat rusak akibat benda-benda lancip, seperti jarum, obeng, atau tekanan keras dari luar.** Hal ini dapat menyebabkan terjading hubungan singkat internal dan baterai dapat terbakar, berasap, meledak, atau mengalami panas berlebih.
- ▶ **Jika baterai tidak digunakan, jauhkan baterai dari klip kertas, uang logam, kunci, paku, sekrup, atau benda-benda kecil dari logam lainnya, yang dapat menjembatani kontak-kontak.** Korsleting antara kontak-kontak baterai dapat mengakibatkan kebakaran atau api.
- ▶ **Hanya gunakan baterai pada produk yang dibuat oleh produsen.** Hanya dengan cara ini, baterai dapat terlindung dari kelebihan muatan.
- ▶ **Hanya isi ulang daya baterai menggunakan alat pengisi daya yang dianjurkan oleh produsen.** Alat pengisi daya baterai yang khusus untuk mengisi daya baterai tertentu dapat mengakibatkan kebakaran jika digunakan untuk mengisi daya baterai yang tidak cocok.



**Lindungi baterai dari panas, misalnya juga dari paparan sinar matahari dalam waktu yang lama, api, kotoran, air dan kelembapan.** Terdapat risiko ledakan dan korsleting.



- ▶ **Jangan gunakan kacamata pelihat laser (aksesori) sebagai kacamata pelindung.** Kacamata pelihat laser digunakan untuk mendeteksi sinar laser dengan lebih baik, namun tidak melindungi dari sinar laser.
  - ▶ **Jangan gunakan kacamata pelihat laser (aksesori) sebagai kacamata hitam atau di jalan raya.** Kacamata pelihat laser tidak menawarkan perlindungan penuh terhadap sinar UV dan mengurangi persepsi warna.
  - ▶ **Alat ukur dilengkapi dengan antarmuka nirkabel. Perhatikan batasan pengoperasian lokal, misalnya dalam pesawat terbang atau di rumah sakit.**
- Istilah merek *Bluetooth®* serta gambar simbol (logo) merupakan merek dagang terdaftar dan kepemilikan dari Bluetooth SIG, Inc. Setiap penggunaan istilah merek/ gambar simbol ini berada di bawah lisensi Robert Bosch Power Tools GmbH.
- ▶ **Waspada! Ketika menggunakan alat ukur dengan *Bluetooth®* dapat terjadi gangguan pada perangkat dan instalasi lain, pesawat terbang, dan perangkat medis (misalnya alat pacu jantung, alat bantu dengar). Selain itu, cedera pada manusia dan binatang di area sekitar tidak dapat sepenuhnya dihindari. Jangan menggunakan alat ukur dengan *Bluetooth®* di dekat perangkat medis, pusat pengisian bahan bakar, instalasi kimia, area dengan bahaya ledakan. Jangan menggunakan alat ukur dengan *Bluetooth®* dalam pesawat terbang. Hindari pengoperasian di dekat tubuh secara langsung dalam waktu yang lama.**

## Petunjuk keselamatan untuk adaptor daya

- ▶ **Adaptor daya ini tidak dirancang untuk digunakan oleh anak-anak dan orang dengan keterbatasan fisik, sensorik atau mental atau yang kurang pengalaman dan pengetahuan. Adaptor daya ini dapat digunakan oleh anak-anak dengan usia di atas 8 tahun dan juga orang dengan keterbatasan fisik, sensorik atau mental, atau kurang berpengalaman dan pengetahuan selama di bawah pengawasan orang yang bertanggung jawab atau diberi pengarahan mengenai cara penggunaan adaptor yang aman dan mereka dapat mengerti tentang bahaya yang mungkin terjadi. Jika tidak, hal tersebut dapat menimbulkan risiko kesalahan pengoperasian dan menyebabkan cedera.**



**Jauhkan adaptor daya dari hujan atau basah.** Air yang masuk ke dalam adaptor daya akan meningkatkan risiko terjadinya sengatan listrik.

- ▶ **Jaga kebersihan adaptor daya.** Kondisi adaptor daya yang kotor dapat menimbulkan bahaya sengatan listrik.
- ▶ **Periksa adaptor daya setiap sebelum digunakan. Jangan gunakan adaptor daya jika terlihat adanya kerusakan. Jangan membuka sendiri adaptor daya dan**

**adaptor daya hanya boleh diperbaiki oleh Bosch atau oleh pusat layanan pelanggan resmi dan hanya dengan suku cadang asli.** Adaptor daya yang rusak akan meningkatkan risiko terjadinya sengatan listrik.

## Spesifikasi produk dan performa

### Tujuan penggunaan







Alat pengukur merupakan instrumen untuk mengukur jarak, panjang, tinggi, celah dan untuk menghitung luas bidang dan volume.

Alat pengukur ini cocok untuk penggunaan di dalam gedung.

Hasil ukur dapat dikirim melalui *Bluetooth*<sup>®</sup> ke perangkat lainnya.

### Ilustrasi komponen

Penomoran ilustrasi komponen mengacu pada ilustrasi alat ukur pada halaman ilustrasi.

- (1)  Tombol *Bluetooth*<sup>®</sup>
- (2)  Tombol fungsi
- (3)  Tombol minus
- (4) Display
- (5)  Tombol pengukuran
- (6)  Tombol plus
- (7)  Tombol pengaturan dasar
- (8)  Tombol on/off/kembali
- (9) Slot untuk tali jinjing
- (10) Label peringatan laser
- (11) Nomor seri
- (12) Pengunci tutup kompartemen baterai
- (13) Tutup kompartemen baterai
- (14) Ullir tripod 1/4"
- (15) Lensa penerima

- (16) Outlet sinar laser
- (17) Tali pengangkat<sup>A)</sup>
- (18) Tas pelindung
- (19) Set baterai Li-ion<sup>A)</sup>
- (20) Penguncian set baterai Li-ion<sup>A)</sup>
- (21) Kabel USB Type-C<sup>®A)B)</sup>
- (22) Penutup soket USB<sup>A)</sup>
- (23) Klip sabuk<sup>A)</sup>
- (24) Sekrup untuk klip sabuk<sup>A)</sup>
- (25) Tripod<sup>A)</sup>
- (26) Reflektor sinar laser<sup>A)</sup>
- (27) Kacamata laser<sup>A)</sup>

A) **Aksesori yang digambarkan atau yang dijelaskan tidak termasuk dalam lingkup pengiriman standar. Semua aksesori yang ada dapat ditemukan dalam program aksesori kami.**

B) USB Type-C<sup>®</sup> dan USB-C<sup>®</sup> merupakan merek dagang dari USB Implementer Forum.

#### **Elemen pada display**

- (a) Bidang acuan pengukuran
- (b) Status *Bluetooth*<sup>®</sup>
  - \* *Bluetooth*<sup>®</sup> diaktifkan, koneksi tidak dibuat
  - \*• *Bluetooth*<sup>®</sup> diaktifkan, koneksi dibuat
- (c) Indikator baterai
- (d) Baris nilai pengukuran
- (e) Baris hasil pengukuran
- (f) Display fungsi pengukuran
- (g) Tampilan sudut kemiringan
- (h) Bar status
- (i) Menu Fungsi

- (j) Menu Pengaturan dasar
- (k) Menu Pengaturan dasar selanjutnya

## Data teknis

Laser pengukur jarak digital	GLM 50-27 CG
Nomor seri	<b>3 601 K72 U..</b>
Jangkauan pengukuran <sup>A)</sup>	0,05–50 m
Jangkauan pengukuran (kondisi tidak menguntungkan) <sup>B)</sup>	0,05–20 m
Akurasi pengukuran <sup>A)</sup>	±1,5 mm
Akurasi pengukuran (kondisi tidak menguntungkan) <sup>B)</sup>	±3,0 mm
Unit terkecil pada display	0,5 mm
<b>Umum</b>	
Suhu pengoperasian <sup>C)</sup>	-10 °C ... +45 °C
Suhu penyimpanan	-20 °C ... +70 °C
Kelembapan relatif maks.	90%
Tinggi penggunaan maks. di atas tinggi acuan	2000 m
Tingkat polusi sesuai dengan IEC 61010-1	2 <sup>D)</sup>
Kelas laser	2
Jenis laser	515 nm, < 1 mW
Divergensi sinar laser	< 1,5 mrad (sudut penuh)
Penonaktifan otomatis setelah sekitar	
– Laser	20 detik
– Alat pengukur (tanpa pengukuran) <sup>E)</sup>	5 menit
<b>Pengukuran jarak tidak langsung dan waterpas</b>	
Jangkauan pengukuran	0°–360° (4 × 90°)
<b>Pengukuran kemiringan</b>	
Jangkauan pengukuran	0°–360° (4 × 90°)
Akurasi pengukuran <sup>F)</sup> <sup>G)</sup>	± 0,2°
Unit terkecil pada display	0,1°

<b>Laser pengukur jarak digital</b>		<b>GLM 50-27 CG</b>
Berat sesuai dengan EPTA-Procedure 01:2014		0,17 kg
Tingkat perlindungan		IP 65 (terlindung dari debu dan percikan air)
Ukuran		119 × 53 × 29 mm
Pengaturan satuan ukur		m, ft, in
Baterai		2 × 1,5 V LR6 (AA)
<b>Set baterai (aksesori)</b>		<b>Baterai Li-ion</b>
Tipe		BA 3.7V 1.0Ah A
Nomor seri		<b>1 607 A35 17H</b>
Port pengisian daya USB		Tipe-C®
Tegangan nominal		3,7 V ---
Kapasitas		1,0 Ah
Jumlah sel baterai		1
Rentang suhu pengisian daya yang diizinkan		+10 °C ... +35 °C
<b>Adaptor daya</b>		
Tegangan output		5,0 V ---
Arus output minimal		500 mA
<b>Pengiriman data</b>		
<i>Bluetooth®</i>		<i>Bluetooth® 4.2 (Low Energy)<sup>(H)</sup></i>
Rentang frekuensi pengoperasian		2402–2480 MHz

Daya transmisi maks.

8 mW

- A) Saat mengukur dari tepi depan alat ukur, berlaku untuk daya pantul objek yang tinggi (misalnya dinding yang dicat putih), pencahayaan latar belakang yang lemah dan suhu pengoperasian sebesar 20 °C; selain itu, harus diperhitungkan penyimpangan bergantung jarak sebesar  $\pm 0,05$  mm/m.
  - B) Saat mengukur dari tepi depan alat ukur, berlaku untuk daya pantul objek yang tinggi (misalnya dinding yang dicat putih), pencahayaan latar belakang yang kuat, suhu pengoperasian sebesar 20 °C dan altitudo yang besar; selain itu, harus diperhitungkan penyimpangan bergantung jarak sebesar  $\pm 0,15$  mm/m.
  - C) Suhu pengoperasian maksimal pada fungsi pengukuran kontinu yakni +40 °C.
  - D) Hanya polusi nonkonduktif yang terjadi, namun terkadang muncul konduktivitas sementara yang disebabkan oleh kondensasi.
  - E) *Bluetooth*® dinonaktifkan
  - F) Pada suhu pengoperasian 25 °C
  - G) Setelah kalibrasi pengguna pada suhu 0° dan 90°; tingkat kesalahan gradien tambahan sebesar  $\pm 0,01^\circ$ /derajat hingga 45° (maks.) perlu diperhatikan. Sisi kiri alat pengukur digunakan sebagai bidang acuan untuk mengukur kemiringan.
  - H) Sambungan mungkin tidak dapat dibuat pada perangkat *Bluetooth*® Low Energy tergantung pada model dan sistem pengoperasian. Perangkat *Bluetooth*® harus mendukung profil GATT.
- Untuk mengidentifikasi alat pengukur secara jelas terdapat nomor seri **(11)** pada label tipe.

## Memasang/mengganti baterai

Direkomendasikan untuk menggunakan baterai mangan alkali atau baterai NiMH untuk pengoperasian alat ukur (terutama ketika suhu pengoperasian rendah).

Pengukuran dapat dilakukan lebih banyak dengan baterai 1,2 V daripada menggunakan baterai 1,5 V bergantung pada kapasitas baterai.

» Buka tutup kompartemen baterai.

» Masukkan baterai.

**i** Selalu ganti semua baterai atau baterai isi ulang sekaligus. Hanya gunakan baterai atau baterai isi ulang dari produsen dan dengan kapasitas yang sama.

**i** Pastikan baterai terpasang pada posisi kutub yang benar sesuai gambar di dalam kompartemen baterai.

Ketika level pengisian daya baterai rendah, pada display akan muncul pertanyaan untuk mengaktifkan mode hemat baterai. Ketika mode hemat baterai telah diaktifkan, masa pengoperasian baterai akan menjadi lebih lama dan simbol baterai pada display akan

dikelilingi warna kuning . (lihat „Mengaktifkan/menonaktifkan mode hemat baterai “ , Halaman 196)

Hanya sedikit pengukuran yang dapat dilakukan apabila muncul simbol baterai kosong pada display untuk kali pertama.

Jika simbol baterai kosong dan berkedip merah, pengukuran tidak dapat lagi dilakukan. Ganti baterai.

- ▶ **Lepaskan baterai atau baterai isi ulang dari alat pengukur jika alat pengukur tidak digunakan dalam waktu yang lama.** Jika baterai dan baterai isi ulang disimpan untuk waktu yang lama, baterai dan baterai isi ulang dapat berkarat dan dayanya akan habis dengan sendirinya.

 Jangan pernah menyimpan alat ukur tanpa tutup kompartemen baterai **(13)** atau set baterai Li-ion **(19)** (aksesori) yang terpasang terutama pada kondisi berdebu atau lembap.

## Set baterai Li-ion (aksesori)

### Memasang/mengganti set baterai Li-ion (aksesori)

- » Pasang set baterai Li-ion **(19)** (aksesori).
- » Untuk melepas set baterai Li-ion **(19)** (aksesori), tekan pengunci **(20)** lalu keluarkan set baterai Li-ion. (lihat Gbr. A, Halaman 4)

### Mengisi daya set baterai Li-ion (aksesori)

- ▶ **Untuk pengisian daya, gunakan adaptor USB yang direkomendasikan atau adaptor yang memiliki tegangan output dan arus output minimum sesuai dengan persyaratan pada bab "Data Teknis". Perhatikan panduan pengoperasian terkait adaptor USB.**

Adaptor yang direkomendasikan: Lihat "Data Teknis".

- ▶ **Perhatikan tegangan listrik!** Tegangan pada sumber listrik harus sesuai dengan informasi yang tercantum pada label tipe adaptor daya. Adaptor daya bertanda 230 V juga dapat dioperasikan pada 220 V.

 Baterai ion litium dikirim dengan keadaan telah terisi daya sebagian berdasarkan peraturan transportasi internasional. Untuk menjamin kapasitas penuh baterai, isilah daya baterai hingga penuh sebelum penggunaan untuk kali pertama.

Soket USB untuk menyambungkan kabel USB **(21)** dan lampu indikator pengisian daya berada di bawah penutup soket USB **(22)** pada set baterai Li-ion **(19)** (aksesori).

- » Buka penutup soket USB **(22)**.
- » Tutup kabel USB **(21)**.

Selama proses pengisian daya, indikator baterai pada display dapat berbeda dengan status pengisian daya set baterai Li-ion **(19)** (aksesori) yang sebenarnya.

Selama pengisian daya, lampu indikator pengisian daya akan menyala kuning.

Jika set baterai Li-Ion **(19)** (aksesori) telah terisi daya penuh, lampu indikator pengisian daya akan menyala hijau.

Lampu indikator pengisian daya yang menyala merah menandakan tegangan pengisian daya atau arus pengisian daya tidak sesuai.

## Penggunaan

### Cara penggunaan

- ▶ **Jangan biarkan alat ukur yang aktif berada di luar pengawasan dan matikan alat ukur setelah digunakan.** Sinar laser dapat menyilaukan mata orang lain.
- ▶ **Lindungilah alat ukur dari cairan dan sinar matahari langsung.**
- ▶ **Jauhkan alat ukur dari suhu atau perubahan suhu yang ekstrem.** Jangan biarkan alat ukur berada terlalu lama di dalam kendaraan. Biarkan alat ukur menyesuaikan suhu lingkungan sebelum dioperasikan saat terjadi perubahan suhu yang drastis. Pada suhu yang ekstrem atau terjadi perubahan suhu yang drastis, ketepatan alat ukur dapat terganggu.
- ▶ **Hindari guncangan atau benturan yang keras pada alat ukur.** Setelah terjadi guncangan atau benturan keras pada alat ukur, disarankan untuk selalu memeriksa akurasi alat (lihat „Pemeriksaan akurasi“, Halaman 212) sebelum menggunakan kembali.

### Menghidupkan/mematikan

- » Tekan tombol  untuk menghidupkan alat ukur dan menyalakan laser.

Alat ukur juga dapat dihidupkan tanpa menyalakan laser dengan menekan tombol .

- » Tekan dan tahan tombol  untuk mematikan alat ukur.



Pengaturan alat dan nilai yang disimpan pada memori akan tetap tersimpan.



## Prosedur pengukuran

Setelah dihidupkan untuk kali pertama, alat pengukur akan berada dalam fungsi pengukuran panjang. Setiap setelah dihidupkan di waktu berikutnya, alat pengukur berada dalam fungsi pengukuran yang digunakan terakhir kali.

Tiga pengaturan tersedia untuk bidang acuan pengukuran. (lihat „Memilih bidang acuan“, Halaman 194)

- » Letakkan alat pengukur pada titik awal pengukuran yang diinginkan (misalnya dinding).
- » Jika alat ukur dihidupkan dengan tombol , selanjutnya tekan singkat tombol  untuk mengaktifkan laser.
- » Tekan tombol  untuk memulai pengukuran.

Sinar laser akan dimatikan setelah proses pengukuran selesai. Ulangi prosedur ini untuk pengukuran selanjutnya.

Nilai pengukuran atau hasil akhir dapat ditambah atau dikurangi.

Nilai pengukuran biasanya muncul dalam waktu 0,5 detik dan paling lambat setelah sekitar 4 detik.

Durasi pengukuran bergantung pada jarak, kondisi cahaya, dan karakter pantulan permukaan target. Sinar laser akan dimatikan secara otomatis setelah proses pengukuran selesai.

 Alat ukur tidak boleh digerakkan selama proses pengukuran (kecuali pada fungsi pengukuran kontinu dan pengukuran kemiringan). Oleh karena itu, sebisa mungkin letakkan alat ukur di atas permukaan atau dudukan yang kokoh dan stabil.

 Lensa penerima **(15)** dan outlet sinar laser **(16)** tidak boleh terhalang saat pengukuran berlangsung.

### Hal-hal yang memengaruhi jangkauan pengukuran

Jangkauan pengukuran bergantung pada kondisi cahaya dan karakter pantulan permukaan target.

Agar sinar laser memiliki visibilitas yang lebih baik ketika cahaya sekitar terlalu terang, gunakan kacamata laser **(27)** (aksesori) dan reflektor sinar laser **(26)** (aksesori), atau naungi permukaan target.

### Hal-hal yang memengaruhi hasil pengukuran

Faktor-faktor fisik yang menyebabkan ketidaktepatan pengukuran saat mengukur di berbagai permukaan tidak dapat diabaikan. Hal ini mencakup:

- Permukaan yang transparan (misalnya kaca, air),
- Permukaan yang memantul (misalnya logam yang dipoles, kaca),
- Permukaan yang berpori (material insulasi),
- Permukaan bertekstur (misalnya dinding plester, batu alam).

Jika diperlukan, gunakan reflektor sinar laser **(26)** (aksesori) pada permukaan tersebut. Ketidaktepatan pengukuran juga dapat terjadi pada permukaan target yang dibidik secara miring.

Lapisan udara dengan suhu yang berbeda atau pantulan yang diterima secara tidak langsung juga dapat memengaruhi nilai pengukuran.

## Navigasi dalam menu

Gunakan tombol  untuk beralih ke kanan dan tombol  untuk beralih ke kiri dalam menu.

Untuk mengonfirmasi pilihan, tekan tombol  atau tombol .

Tekan tombol  untuk keluar dari menu.

## Memilih bidang acuan

Untuk pengukuran, bidang acuan yang berbeda-beda dapat dipilih:



Tepi belakang alat ukur (misalnya saat diletakkan pada dinding),





Bagian tengah ulir tripod **(14)** (misalnya saat mengukur menggunakan tripod)



Tepi depan alat ukur (misalnya saat mengukur dari tepi meja)

» Tekan tombol  untuk membuka menu **Pengaturan dasar**.

» Pilih .

» Pilih bidang acuan yang diinginkan dengan tombol  atau tombol .











» Tekan tombol  untuk mengonfirmasi pilihan.







Bidang acuan yang dipilih terakhir kali akan diatur sebelumnya begitu alat pengukur dihidupkan.

Bidang acuan pada pengukuran yang telah dilakukan tidak dapat diubah setelahnya (misalnya ketika nilai pengukuran ditampilkan pada daftar nilai pengukuran).

## Menu Pengaturan dasar









Pengaturan dasar berikut dapat ditemukan pada menu **Pengaturan dasar**:

-  Mengubah bidang acuan (lihat „Memilih bidang acuan“, Halaman 194)
-  Menghidupkan/mematikan sinyal suara
-  Mengaktifkan/menonaktifkan getaran
-  Mengatur kecerahan display
-  Mengaktifkan/menonaktifkan mode hemat baterai
-  Mengubah satuan ukur
-  Mengatur bahasa
-  Kalibrasi pengukuran kemiringan (lihat „Pemeriksaan akurasi“, Halaman 212)
-  Mengakses informasi alat
-  Pengaturan pabrik
-  Menghapus memori

- » Tekan tombol  untuk membuka menu **Pengaturan dasar**.
- » Pilih pengaturan yang diinginkan dengan tombol  atau tombol .
- » Untuk mengonfirmasi pilihan, tekan tombol  atau tombol .
- » Untuk keluar dari menu **Pengaturan dasar**, tekan singkat tombol .

## Menghidupkan/mematikan sinyal suara

Bunyi diaktifkan pada pengaturan dasar.









- » Tekan tombol  untuk mengakses menu **Pengaturan dasar** .
- » Pilih .
- » Tekan tombol  atau tombol  untuk mengubah pilihan.
- » Tekan tombol  atau tombol  untuk mengonfirmasi pilihan.
- » Untuk keluar dari menu **Pengaturan dasar** , tekan singkat tombol .

Setelah mematikan alat pengukur, pengaturan yang dipilih akan tetap tersimpan.

### Mengaktifkan/menonaktifkan getaran

Getaran diaktifkan pada pengaturan dasar.









Getaran pada alat pengukur dapat berguna misalnya dalam situasi yang bising. Dua getaran singkat menandakan bahwa pengukuran berhasil, getaran yang panjang menandakan bahwa pengukuran tidak tepat.

- » Tekan tombol  untuk mengakses menu **Pengaturan dasar** .
- » Pilih .
- » Tekan tombol  atau tombol  untuk mengubah pilihan.
- » Tekan tombol  atau tombol  untuk mengonfirmasi pilihan.
- » Untuk keluar dari menu **Pengaturan dasar** , tekan singkat tombol .

Setelah mematikan alat pengukur, pengaturan yang dipilih akan tetap tersimpan.

### Mengatur kecerahan display



Kecerahan display dapat disesuaikan dengan kondisi sekitar dalam beberapa level.







- » Tekan tombol  untuk mengakses menu **Pengaturan dasar** .
- » Pilih .
- » Tekan tombol  atau tombol  untuk mengubah pilihan.
- » Tekan tombol  atau tombol  untuk mengonfirmasi pilihan.
- » Untuk keluar dari menu **Pengaturan dasar** , tekan singkat tombol .

Setelah mematikan alat pengukur, pengaturan yang dipilih akan tetap tersimpan.

### Mengaktifkan/menonaktifkan mode hemat baterai









Mode hemat baterai dinonaktifkan pada pengaturan dasar. Ketika mode hemat baterai diaktifkan, bunyi dan getaran akan dinonaktifkan dan kecerahan display akan dikurangi. Dengan begitu, masa pengoperasian baterai menjadi lebih panjang.

- » Tekan tombol  untuk mengakses menu **Pengaturan dasar** .
- » Pilih .

- » Tekan tombol  atau tombol  untuk mengubah pilihan.
  - » Tekan tombol  atau tombol  untuk mengonfirmasi pilihan.
  - » Untuk keluar dari menu **Pengaturan dasar** , tekan singkat tombol .
- Setelah mematikan alat pengukur, pengaturan yang dipilih akan tetap tersimpan.

### Mengubah satuan ukur











Satuan ukur dalam pengaturan dasar adalah "m" (meter). Terdapat enam satuan ukur yang berbeda. Atur satuan ukur yang tepat sesuai tujuan.

- » Tekan tombol  untuk mengakses menu **Pengaturan dasar** .
  - » Pilih .
  - » Tekan tombol  atau tombol  untuk mengubah pilihan.
  - » Tekan tombol  atau tombol  untuk mengonfirmasi pilihan.
  - » Untuk keluar dari menu **Pengaturan dasar** , tekan singkat tombol .
- Setelah mematikan alat pengukur, pengaturan yang dipilih akan tetap tersimpan.

### Mengatur bahasa







Saat menghidupkan alat pengukur untuk kali pertama, pengguna diminta untuk mengatur bahasa favorit untuk teks display.

Bahasa yang diatur dapat diubah setiap saat.

- » Tekan tombol  untuk mengakses menu **Pengaturan dasar** .
  - » Pilih  untuk pengaturan lainnya.
  - » Pilih .
  - » Tekan tombol  atau tombol  untuk mengubah pilihan.
  - » Tekan tombol  atau tombol  untuk mengonfirmasi pilihan.
  - » Untuk keluar dari menu **Pengaturan dasar** , tekan singkat tombol .
- Setelah mematikan alat pengukur, pengaturan yang dipilih akan tetap tersimpan.









## Informasi perangkat

Informasi mengenai alat ukur seperti misalnya nomor seri, versi perangkat lunak, dan lisensi dapat ditemukan di sini.









- » Tekan tombol  untuk mengakses menu **Pengaturan dasar** .
- » Pilih  untuk pengaturan lainnya.
- » Pilih .
- » Untuk keluar dari menu **Pengaturan dasar** , tekan singkat tombol .

## Pengaturan pabrik

Fungsi ini digunakan untuk mereset alat pengukur ke pengaturan pabrik/pengaturan dasar. Setelah direset, pengguna diminta untuk mengatur bahasa favorit untuk display.

- » Tekan tombol  untuk mengakses menu **Pengaturan dasar** .
- » Pilih  untuk pengaturan lainnya.
- » Pilih .
- » Untuk mereset alat ukur, pilih  dan konfirmasi dengan tombol  atau tombol .
- » Untuk keluar dari menu **Pengaturan dasar** , tekan singkat tombol .













## Menghapus memori

- » Tekan tombol  untuk mengakses menu **Pengaturan dasar** .
  - » Pilih  untuk pengaturan lainnya.
  - » Pilih .
  - » Untuk menghapus memori, pilih  dengan tombol  atau tombol  dan konfirmasi dengan tombol  atau tombol .
- Semua nilai pengukuran akan dihapus.

## Fungsi pengukuran

### Memilih/mengubah fungsi pengukuran

Temukan fungsi berikut pada menu Fungsi:

-  Pengukuran panjang
-  Pengukuran kontinu
-  Pengukuran luas
-  Pengukuran volume
-  Pengukuran jarak tidak langsung
  -  Pengukuran tinggi tidak langsung
  -  Pengukuran tinggi tidak langsung ganda
  -  Pengukuran panjang tidak langsung
-  Pengukuran luas dinding
-  Fungsi patok
-  Pengukuran kemiringan/waterpas digital
-  Fungsi memori

» Tekan tombol  untuk membuka menu **Fungsi**.

» Pilih fungsi pengukuran yang diinginkan dengan tombol  atau tombol .

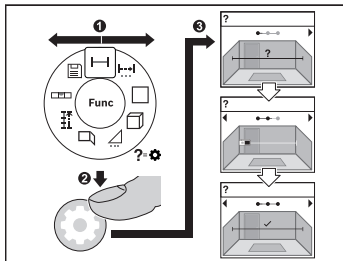

» Tekan tombol  atau tombol  untuk mengonfirmasi pilihan.

### Fungsi bantuan terintegrasi ?



Fungsi bantuan yang terintegrasi pada alat ukur menawarkan detail animasi pada semua fungsi pengukuran/proses pengukuran.

» Buka menu **Fungsi**.





» Pilih fungsi yang diinginkan dengan tombol  atau tombol  dan tekan tombol .

Animasi dengan detail prosedur pada

fungsi pengukuran yang dipilih akan ditampilkan.

» Tekan tombol  atau  untuk menampilkan langkah berikutnya atau sebelumnya.

### Pengukuran panjang

- » Tekan tombol  untuk membuka menu **Fungsi**.
- » Pilih pengukuran panjang  dan konfirmasi pilihan dengan tombol .
- » Tekan singkat tombol  untuk menyalakan laser.
- » Tekan tombol  untuk memulai pengukuran.





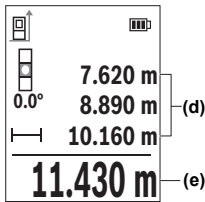

Nilai pengukuran akan ditunjukkan pada baris hasil **(e)** pada display bawah.

» Ulangi langkah di atas saat setiap kali mengukur.



Saat melakukan beberapa pengukuran panjang secara berturut-turut, hasil ukur yang terakhir akan ditunjukkan pada baris nilai pengukuran **(d)**. Nilai pengukuran terakhir terletak pada display bagian bawah, nilai kedua terakhir berada di atasnya dan seterusnya.

### Pengukuran luas

- » Tekan tombol  untuk membuka menu **Fungsi**.
- » Pilih pengukuran luas  dan konfirmasi pilihan dengan tombol .
- » Tekan singkat tombol  untuk menyalakan laser.
- » Tekan tombol  untuk memulai pengukuran pertama, misalnya panjang ruang.
- » Tekan tombol  untuk memulai pengukuran kedua, misalnya lebar ruang.



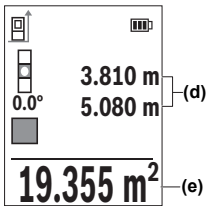

Setelah pengukuran kedua selesai, luas permukaan secara otomatis dihitung dan ditampilkan. Hasilnya akan ditunjukkan pada baris hasil **(e)**. Nilai pengukuran masing-masing dapat ditemukan pada baris nilai pengukuran **(d)**.

### Pengukuran kontinu $\leftarrow \rightarrow$

Pada pengukuran kontinu, nilai pengukuran akan terus-menerus diperbarui. Pengguna dapat menjauh misalnya dari dinding hingga ke suatu jarak yang diinginkan selama jarak saat ini selalu dapat terbaca.

Tiga fungsi tersedia untuk pengukuran kontinu yang masing-masing menampilkan pengukuran dengan tampilan yang berbeda pada display:

#### min/maks $\begin{matrix} \min \\ \max \end{matrix}$

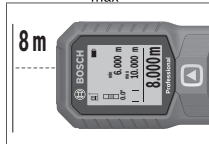

Nilai pengukuran terkecil dan terbesar akan ditampilkan secara permanen pada display.

- » Tekan tombol **Func** untuk membuka menu **Fungsi**.
- » Pilih opsi min/maks  $\begin{matrix} \min \\ \max \end{matrix}$  pada item menu Pengukuran kontinu  $\leftarrow \rightarrow$  dan konfirmasi pilihan dengan tombol **Func**.

- » Tekan singkat tombol **▲** untuk menyalakan laser.
- » Gerakan alat pengukur beberapa saat hingga jarak yang diinginkan muncul pada baris hasil.

Pengukuran kontinu dapat dibatalkan dengan menekan singkat tombol **▲**.

- » Tekan kembali tombol **▲** untuk melanjutkan pengukuran kontinu.

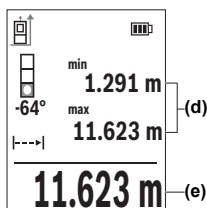

Nilai pengukuran saat ini ditampilkan pada baris hasil **(e)**, nilai pengukuran maksimal dan minimal ditampilkan pada baris nilai pengukuran **(d)**.

### Nilai sebenarnya 0<sup>+</sup>

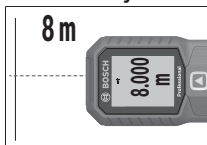

Nilai pengukuran akan ditampilkan dan diperbesar agar dapat terbaca dengan lebih jelas.

### Pita pengukur

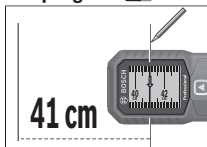







Jarak akan ditampilkan secara visual seperti pada pita pengukur.

**i** Pada fungsi pita pengukur, bidang acuan merupakan penanda yang ditampilkan pada display. Ujung alat pengukur bukanlah bidang acuan.

Pengukuran kontinu akan nonaktif secara otomatis setelah **4** menit.

### Pengukuran volume

- » Tekan tombol  untuk membuka menu **Fungsi**.
- » Pilih pengukuran volume  dan konfirmasi pilihan dengan tombol .
- » Tekan singkat tombol  untuk menyalakan laser.
- » Tekan tombol  untuk memulai pengukuran pertama, misalnya panjang ruang.
- » Tekan tombol  untuk memulai pengukuran kedua, misalnya lebar ruang.

» Tekan tombol ▲ untuk memulai pengukuran ketiga, misalnya tinggi ruang.

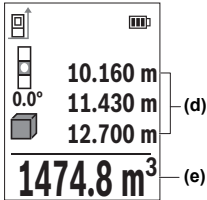

Setelah pengukuran ketiga selesai, volume secara otomatis dihitung dan ditampilkan. Hasilnya akan ditunjukkan pada baris hasil **(e)**. Nilai pengukuran masing-masing dapat ditemukan pada baris nilai pengukuran **(d)**.

### Pengukuran jarak tidak langsung



Pengukuran jarak tidak langsung digunakan untuk menentukan jarak yang tidak dapat diukur secara langsung karena ada sesuatu yang menghalangi jalannya sinar atau tidak ada permukaan target yang tersedia sebagai reflektor. Cara pengukuran ini hanya dapat dilakukan dalam arah vertikal. Segala penyimpangan dalam arah horizontal akan menyebabkan kesalahan dalam pengukuran.

Pengukuran jarak tidak langsung selalu kurang akurat bila dibandingkan dengan pengukuran jarak langsung. Kesalahan pengukuran dapat lebih besar daripada pada pengukuran jarak langsung tergantung pada penggunaannya. Untuk meningkatkan akurasi pengukuran, direkomendasikan untuk menggunakan tripod (aksesori).

 Saat menggunakan tripod, perhatikan bidang acuan yang telah diatur. (lihat „Memilih bidang acuan“, Halaman 194)

Sinar laser akan tetap menyala di antara proses pengukuran tunggal.

Tersedia **3** fungsi pengukuran pada pengukuran jarak tidak langsung dan tiap-tiap fungsi tersebut dapat digunakan untuk menentukan jarak yang berbeda-beda:





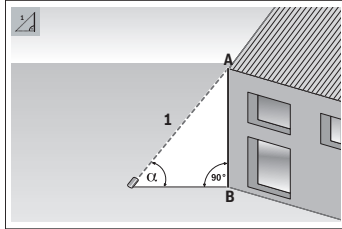

-  Pengukuran tinggi tidak langsung
-  Pengukuran tinggi tidak langsung ganda
-  Pengukuran panjang tidak langsung

### Pengukuran tinggi tidak langsung



Dengan pengukuran tinggi tidak langsung, jarak **AB** dapat ditentukan dengan mengukur jarak **1**. Alat ukur akan menghitung tinggi **AB** yang dicari dari sudut  $\alpha$  dan jarak **1**.

Hasil yang tepat hanya akan diperoleh jika sudut siku-siku yang diperlukan pada tiap-tiap pengukuran benar-benar dipatuhi.

- » Tekan tombol  untuk membuka menu **Fungsi**.
- » Pilih pengukuran jarak tidak langsung  dan konfirmasi pilihan dengan tombol .
- » Pilih pengukuran tinggi tidak langsung  dan konfirmasi pilihan dengan tombol .
- » Tekan singkat tombol  untuk menyalakan laser.
- » Letakkan alat ukur pada tinggi titik ukur bawah **B**.
- » Miringkan alat ukur sehingga laser mengarah ke titik ukur atas **A**.
- » Tekan tombol  untuk memulai pengukuran.

Setelah pengukuran selesai, tinggi secara otomatis dihitung dan ditunjukkan pada baris hasil **(e)**. Nilai pengukuran untuk jarak **1** dan sudut  $\alpha$  terdapat di baris nilai pengukuran **(d)**.



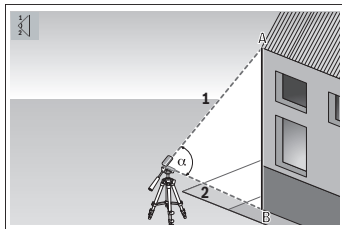



### Pengukuran tinggi tidak langsung ganda



Dengan pengukuran tinggi tidak langsung ganda, jarak **AB** dapat ditentukan dengan mengukur jarak **1** dan **2**. Alat ukur akan menghitung tinggi **AB** yang dicari dari sudut  $\alpha$  dan jarak **1** dan **2**.







Untuk pengukuran ini, direkomendasikan untuk menggunakan tripod.

- » Tekan tombol  untuk membuka menu **Fungsi**.

- » Pilih pengukuran jarak tidak langsung  dan konfirmasi pilihan dengan tombol .
- » Pilih pengukuran tinggi tidak langsung ganda  dan konfirmasi pilihan dengan tombol .
- » Tekan singkat tombol  untuk menyalakan laser.
- » Miringkan alat ukur sehingga laser mengarah ke titik ukur atas **A**.
- » Tekan tombol  untuk memulai pengukuran pertama.
- » Miringkan alat ukur sehingga laser mengarah ke titik ukur bawah **B**. Saat melakukannya, jangan mengubah posisi alat ukur.
- » Tekan tombol  untuk memulai pengukuran kedua.

Setelah pengukuran selesai, tinggi secara otomatis dihitung dan ditunjukkan pada baris hasil **(e)**. Nilai pengukuran untuk jarak **1**, **2**, dan sudut  $\alpha$  terdapat di baris nilai pengukuran **(d)**.

### Pengukuran panjang tidak langsung

- » Tekan tombol  untuk membuka menu **Fungsi**.
- » Pilih pengukuran jarak tidak langsung  dan konfirmasi pilihan dengan tombol .
- » Pilih pengukuran panjang tidak langsung  dan konfirmasi pilihan dengan tombol .
- » Letakkan alat ukur pada titik awal **A** dari jarak **AB** yang dicari.
- » Miringkan alat ukur sehingga laser mengarah ke bidang tempat titik akhir **B** juga berada.
- » Tekan tombol  untuk memulai pengukuran.

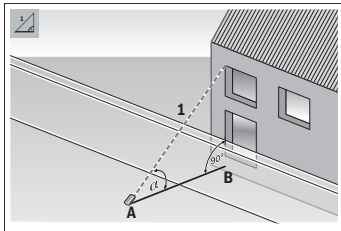

Dengan pengukuran panjang tidak langsung, jarak **AB** dapat ditentukan dengan mengukur jarak **1**. Alat ukur menghitung panjang **AB** yang dicari dari sudut  $\alpha$  dan jarak **1**.

Setelah pengukuran selesai, panjang secara otomatis dihitung dan ditunjukkan pada baris hasil **(e)**. Nilai pengukuran untuk jarak **1** dan sudut  $\alpha$  terdapat di baris nilai pengukuran **(d)**.

### Pengukuran luas dinding

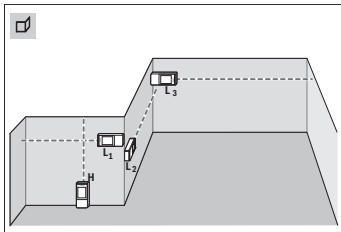

yang sama, tetapi panjang **L** yang berbeda.

Pengukuran luas dinding digunakan untuk menentukan jumlah dari beberapa bidang tunggal dengan ketinggian yang sama. Syarat penghitungan luas permukaan yang benar yakni panjang yang telah diukur pertama (sebagai contoh, tinggi ruang **H**) identik untuk semua luas permukaan parsial. Pada contoh yang digambarkan, luas keseluruhan beberapa dinding perlu ditentukan yang memiliki tinggi ruang **H**

» Tekan tombol  untuk membuka menu **Fungsi**.

» Pilih pengukuran luas dinding  dan konfirmasi pilihan dengan tombol .

» Ukur tinggi ruang **H** seperti saat mengukur panjang.

Nilai pengukuran akan ditampilkan di baris nilai pengukuran bagian atas. Sinar laser tetap menyala.

» Kemudian ukur panjang **L1** dinding pertama.

Luas akan secara otomatis dihitung dan ditampilkan pada baris hasil. Nilai pengukuran panjang terakhir terletak di baris nilai pengukuran bagian bawah. Sinar laser tetap menyala.

» Selanjutnya, ukur panjang **L2** dinding kedua.

Panjang **LX** lainnya dapat diukur secara opsional, kemudian nilai tersebut akan otomatis ditambahkan dan dikalikan dengan tinggi **H**.

Nilai pengukuran tunggal yang ditampilkan pada baris nilai pengukuran (**d**) akan ditambahkan ke panjang **L1**. Jumlah kedua panjang (ditampilkan di baris nilai pengukuran (**d**) bagian tengah) akan dikalikan dengan tinggi **H** yang tersimpan. Nilai luas keseluruhan ditunjukkan pada baris hasil (**e**) pada display bawah.





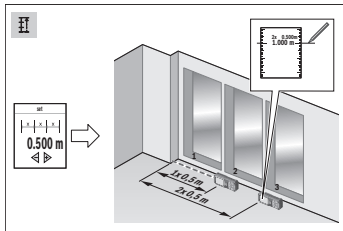

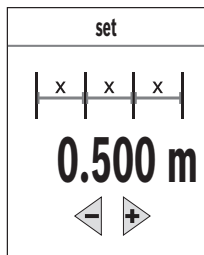

### Fungsi patok

-  Pada fungsi patok, bidang acuan merupakan penanda yang ditampilkan pada display. Ujung alat ukur bukanlah bidang acuan.



Fungsi patok akan mengukur panjang yang ditentukan (jarak) secara berulang. Panjang ini dapat dikirimkan ke permukaan untuk memungkinkan pemotongan material dengan panjang potongan yang sama atau untuk mengatur dinding partisi pada konstruksi drywall. Panjang minimal yang dapat diatur sebesar 0,1 m, panjang maksimal sebesar 50 m.



- » Tekan tombol  untuk membuka menu **Fungsi**.
- » Pilih fungsi patok  dan konfirmasi pilihan dengan tombol .
- » Atur panjang yang diinginkan dengan tombol  atau tombol .
- Tekan lama tombol  atau tombol  untuk menambah ukuran panjang.
- » Tekan tombol  untuk memulai fungsi patok dan

bergeraklah menjauhi titik awal.

Alat ukur terus mengukur jarak ke titik awal. Saat pengukuran, panjang yang telah ditentukan serta nilai pengukuran saat ini akan ditampilkan. Panah bawah atau atas menunjukkan jarak terpendek ke tanda selanjutnya atau sebelumnya.





Koefisien kiri menunjukkan seberapa sering panjang yang ditentukan telah tercapai. Garis-garis hijau di sisi samping pada display menunjukkan panjang yang dicapai untuk tujuan penandaan.



Garis-garis biru dan tulisan biru menunjukkan nilai yang sebenarnya jika nilai acuan berada di luar display.

### Pengukuran kemiringan/waterpas digital

Waterpas digital digunakan untuk memeriksa arah vertikal atau horizontal suatu objek (misalnya mesin cuci, kulkas, dll.). Pengukuran kemiringan digunakan untuk mengukur tanjakan atau kemiringan (misalnya pada tangga, selusur pagar, saat mengukur mebel, saat mengatur posisi pipa, dll.). Alat ukur akan beralih antara dua fungsi secara otomatis apabila posisi alat ukur diubah.

- » Tekan tombol  untuk membuka menu **Fungsi**.
- » Pilih pengukuran kemiringan/waterpas digital  dan konfirmasi pilihan dengan tombol .



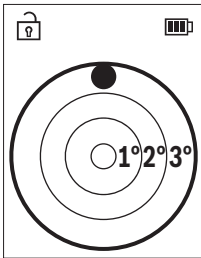

Sisi bawah alat ukur digunakan sebagai bidang acuan untuk waterpas digital.

- » Untuk menggunakan waterpas digital, letakkan alat ukur dengan bagian belakang alat menempel pada permukaan yang akan diukur. Pembacaan nilai pengukuran dapat dihentikan dengan menekan tombol ▲.
- » Jika sudut kemiringan 3° terlampaui, bola pada display akan menyala merah.

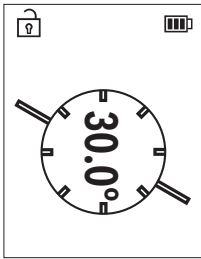





Sisi kiri alat ukur digunakan sebagai bidang acuan untuk mengukur kemiringan. Jika display berkedip selama proses pengukuran berlangsung, alat ukur terlalu miring ke samping.

- » Untuk menggunakan pengukuran kemiringan, letakkan alat ukur dengan permukaan samping di atas objek yang ingin diukur kemiringannya. Pembacaan nilai pengukuran dapat dihentikan dengan menekan tombol ▲.

## Fungsi memori



Nilai atau hasil akhir dari tiap pengukuran yang telah selesai akan tersimpan secara otomatis. **30** nilai terakhir (nilai pengukuran atau hasil akhir) akan disimpan. Jika memori penuh, nilai yang paling lama tersimpan akan ditimpa. Nilai terlama berada di posisi 1 dalam memori, nilai terbaru berada di posisi **30** (pada **30** nilai memori yang tersedia).

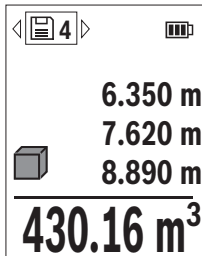

- » Tekan tombol  untuk membuka menu **Fungsi**.
  - » Pilih fungsi memori  dan konfirmasi pilihan dengan tombol .
- Nilai terakhir akan ditampilkan.
- » Tekan tombol  atau tombol  untuk menggulir nilai yang tersimpan.



Angka nilai memori ditampilkan pada display bagian atas dan simbol fungsi pengukuran terkait ditampilkan di sebelah kiri. Jika tidak ada nilai yang tersedia di memori, pada display bagian bawah akan ditampilkan "0.000" dan "0" di bagian atas.

### Menghapus nilai memori

- » Tekan tombol  untuk menghapus nilai yang ditampilkan.
- » Konfirmasi dengan tombol .

Untuk menghapus seluruh nilai yang tersimpan, pada menu **Pengaturan dasar** , pilih item menu **Hapus memori**. (lihat „Menghapus memori “, Halaman 198)

## Menambah/mengurangi nilai

### Menambah nilai saat melakukan pengukuran panjang

- » Pilih fungsi pengukuran panjang.
- » Lakukan pengukuran pertama.
- » Tekan tombol .
- » Lakukan pengukuran kedua.

Begitu pengukuran kedua selesai, hasil dari pengukuran kedua akan ditampilkan pada baris nilai pengukuran **(d)** dan hasil akhir akan ditampilkan pada baris hasil **(e)**.

### Menambah nilai saat melakukan pengukuran luas dan volume

- » Pilih fungsi pengukuran luas atau pengukuran volume.
- » Lakukan pengukuran luas atau pengukuran volume yang pertama.
- » Tekan tombol .

- » Lakukan pengukuran luas atau pengukuran volume yang kedua.

Begitu pengukuran kedua atau ketiga selesai, luas atau volume secara otomatis akan dihitung dan ditampilkan. Hasilnya akan ditunjukkan pada baris hasil **(e)**. Nilai pengukuran masing-masing dapat ditemukan pada baris nilai pengukuran **(d)**.

- » Tekan tombol ▲ untuk menampilkan hasil akhir dari penambahan nilai.

Hasil akhir akan ditunjukkan pada baris hasil **(e)**. Hasil dari pengukuran luas atau volume masing-masing dapat ditemukan pada baris nilai pengukuran **(d)**.

### Mengurangi nilai

- » Untuk mengurangi nilai, tekan tombol ◀. Prosedur selanjutnya sama dengan "Menambah nilai".

### Menghapus nilai pengukuran

Nilai pengukuran yang ditentukan terakhir pada semua fungsi pengukuran dapat dihapus dengan menekan singkat tombol .

Dengan menekan singkat tombol  beberapa kali, nilai pengukuran akan dihapus dalam urutan sebaliknya.

### Antarmuka *Bluetooth*®

#### Pengiriman data ke perangkat lain

Alat pengukur dilengkapi dengan modul *Bluetooth*® yang memungkinkan pengiriman data ke perangkat seluler tertentu dengan antarmuka *Bluetooth*® (misalnya smartphone, tablet) melalui teknologi radio.



Informasi mengenai persyaratan sistem yang diperlukan untuk koneksi *Bluetooth*® dapat dilihat pada situs internet Bosch di [www.bosch-pt.com](http://www.bosch-pt.com).

#### ► Informasi lebih lanjut dapat ditemukan di halaman produk Bosch.

Ketika mengirim data melalui *Bluetooth*®, dapat terjadi penundaan waktu antara perangkat seluler dan alat pengukur. Hal ini dapat disebabkan oleh jarak antara kedua perangkat atau oleh objek pengukuran itu sendiri.

#### Pengaktifan antarmuka *Bluetooth*® untuk pengiriman data pada perangkat seluler

- ✓ Pastikan antarmuka *Bluetooth*® telah diaktifkan pada perangkat seluler.

- » Tekan tombol  untuk mengakses menu *Bluetooth*<sup>®</sup>.
- » Tekan lagi tombol  untuk mengaktifkan antarmuka *Bluetooth*<sup>®</sup>.

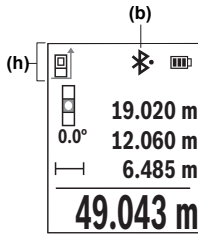



Status koneksi serta koneksi yang aktif **(b)** ditampilkan pada bar status **(h)** dari alat pengukur.

Aplikasi Bosch tersedia untuk memperluas cakupan fungsi. Aplikasi ini dapat diunduh di App Store terkait menyesuaikan perangkatnya.

Setelah memulai aplikasi Bosch, koneksi antara perangkat seluler dengan alat ukur akan dibuat. Pilih alat ukur yang tepat sesuai dengan nomor seri jika ditemukan beberapa alat ukur yang aktif. Nomor seri **(11)** dapat ditemukan di label alat ukur.

### Penonaktifan antarmuka *Bluetooth*<sup>®</sup>

- » Tekan tombol  untuk mengakses menu *Bluetooth*<sup>®</sup> dan tekan lagi tombol  untuk menonaktifkan antarmuka *Bluetooth*<sup>®</sup>.

### Pemeriksaan akurasi



Periksa akurasi pengukuran kemiringan dan pengukuran jarak secara berkala.

#### Pemeriksaan akurasi dan kalibrasi pengukuran kemiringan

- » Untuk melakukannya, letakkan alat ukur pada meja dan ukur kemiringannya.
- » Putar alat ukur sebesar 180° dan ukur kembali kemiringannya.

Selisih nilai yang ditampilkan tidak boleh melebihi 0,3°.

Apabila terdapat selisih yang lebih besar, alat ukur harus dikalibrasi ulang.

- » Tekan tombol  untuk membuka menu **Pengaturan dasar**.
- » Pilih  dan konfirmasi pilihan dengan tombol .
- » Ikuti petunjuk pada display.

 Jika alat mengalami benturan atau perubahan suhu yang besar, direkomendasikan untuk melakukan pemeriksaan akurasi dan bila perlu kalibrasi alat ukur. Setelah mengalami perubahan suhu, suhu alat ukur harus disesuaikan beberapa saat sebelum kalibrasi dilakukan.

### Pemeriksaan akurasi pada pengukuran jarak

Untuk memeriksa akurasi, pengukuran sebaiknya dilakukan pada kondisi yang menguntungkan, yakni jarak pengukuran berada di dalam ruangan dan permukaan target pengukuran harus mulus dan memantulkan cahaya dengan baik (misalnya dinding bercat putih).

- » Pilih jarak pengukuran dengan panjang mulai sekitar **3** hingga **10** m dan panjangnya dapat diketahui dengan pasti (misalnya lebar ruangan, bukaan pintu).
- » Ukur jarak sebanyak 10 kali secara berturut-turut.

Penyimpangan pada pengukuran tunggal dari ukuran yang diketahui dengan pasti maksimal sebesar  $\pm 2$  mm terhadap seluruh jarak pengukuran pada kondisi yang menguntungkan. Catatlah pengukuran tersebut agar akurasinya dapat dibandingkan di lain waktu.

### Bekerja dengan tripod (aksesori)

Tripod sangat diperlukan saat melakukan pengukuran jarak yang lebih besar.

- » Letakkan alat ukur dengan ulir 1/4" (**14**) pada pelat penggantian cepat tripod (**25**) atau tripod foto pada umumnya.
- » Kencangkan alat ukur dengan sekrup pelat penggantian cepat.
- » Atur bidang acuan untuk pengukuran dengan tripod (lihat „Memilih bidang acuan“, Halaman 194).

## Klip sabuk

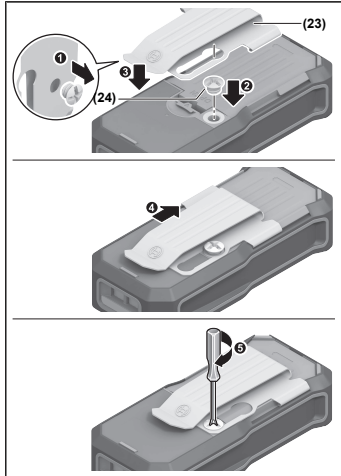

Dengan klip sabuk **(23)**, alat ukur dapat dikaitkan ke sabuk dengan mudah.

Untuk memasang klip sabuk pada alat ukur, ikuti langkah-langkah pada ilustrasi.

## Pesan gangguan

Jika pengukuran tidak dapat dilakukan dengan benar, laporan kesalahan **Error** akan muncul pada display.

- » Cobalah kembali untuk melakukan proses pengukuran.
- » Jika laporan kesalahan kembali muncul, matikan alat pengukur dan hidupkan kembali lalu mulai kembali pengukuran.



Alat ukur memantau ketepatan fungsi pada setiap pengukuran. Apabila terdapat kerusakan, display hanya akan menampilkan simbol di sebelahnya dan alat ukur akan mati. Pada situasi tersebut, kirimkan alat ukur ke layanan pelanggan Bosch melalui dealer Anda.

## Perawatan dan servis

### Perawatan dan pembersihan

Simpan dan bawalah alat pengukur hanya di dalam kantong pelindung yang telah disertakan.

Jaga kebersihan alat.

Jangan memasukkan alat pengukur ke dalam air atau cairan lainnya.

Jika alat kotor, bersihkan dengan lap yang lembut dan lembap. Jangan gunakan bahan pembersih atau zat pelarut.

Rawat lensa penerima **(15)** secara khusus, sama halnya seperti merawat kacamata atau lensa kamera.

Saat alat akan dibawa untuk diperbaiki, simpan alat ukur di dalam tas pelindung **(18)**.

### Layanan pelanggan dan konsultasi penggunaan

Layanan pelanggan Bosch menjawab semua pertanyaan Anda tentang reparasi dan perawatan serta tentang suku cadang produk ini. Gambaran teknis (exploded view) dan informasi mengenai suku cadang dapat ditemukan di: **[www.bosch-pt.com](http://www.bosch-pt.com)**

Tim konsultasi penggunaan Bosch akan membantu Anda menjawab pertanyaan seputar produk kami beserta aksesorinya.

Jika Anda hendak menanyakan sesuatu atau memesan suku cadang, selalu sebutkan nomor model yang terdiri dari 10 angka dan tercantum pada label tipe produk.

#### Indonesia

PT Robert Bosch Indonesia  
Arkadia Green Park Tower G – 7th floor  
Jl. Let. Jend. TB. Simatupang Kav.88  
Jakarta 12520  
Tel.: (021) 3005 5800  
Fax: (021) 3005 5801  
E-Mail: [boschpowertools@id.bosch.com](mailto:boschpowertools@id.bosch.com)  
[www.bosch-pt.co.id](http://www.bosch-pt.co.id)

#### Alamat layanan lainnya dapat ditemukan di:

[www.bosch-pt.com/serviceaddresses](http://www.bosch-pt.com/serviceaddresses)

## Transpor

Baterai li-ion yang direkomendasikan tunduk pada persyaratan terkait peraturan tentang bahan-bahan yang berbahaya. Baterai dapat diangkut di jalan oleh penggunanya tanpa pembatasan lebih lanjut.

Pada pengiriman oleh pihak ketiga (misalnya transportasi udara atau perusahaan ekspedisi) harus ditaati syarat-syarat terkait kemasan dan pemberian tanda. Dalam hal ini, diperlukan konsultasi dengan ahli bahan-bahan berbahaya saat mengatur barang pengiriman.

Kirimkan baterai hanya jika housing-nya tidak rusak. Tutup bagian-bagian yang terbuka dan kemas baterai agar tidak bergerak-gerak di dalam kemasan. Taatilah peraturan-peraturan nasional lainnya yang mungkin lebih rinci yang berlaku di negara Anda.

## Cara membuang



Alat pengukur, aki/baterai, aksesoris dan kemasan harus disortir untuk pendauran ulang yang ramah lingkungan.



Jangan membuang alat pengukur dan baterai bersama dengan sampah rumah tangga!

### Baterai:

### Li-ion:

Perhatikanlah petunjuk-petunjuk dalam bab Transpor (lihat „Transpor“, Halaman 216).

## Aksesoris

Aksesoris dapat ditemukan melalui tautan yang disediakan di situs web Bosch

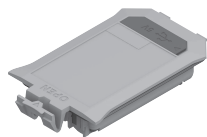

**BA 3.7V 1.0Ah A (19)**  
1 608 M00 C5D



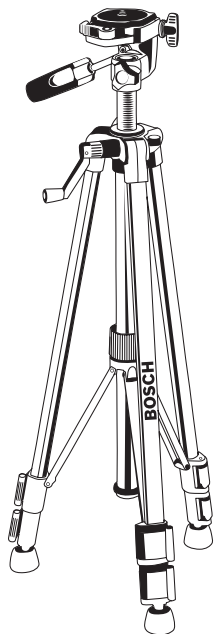

Tripod BT 150 **(25)**  
0 601 096 B00

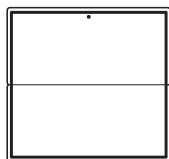

Reflektor sinar laser **(26)**  
2 607 001 391



Kacamata laser (hijau) (27)  
1 608 M00 05J

## Tiếng Việt

### Hướng dẫn an toàn



Phải đọc và chú ý mọi hướng dẫn để đảm bảo an toàn và không bị nguy hiểm khi làm việc với dụng cụ đo. Khi sử dụng dụng cụ đo không phù hợp với các hướng dẫn ở trên, các thiết bị bảo vệ được tích hợp trong dụng cụ đo có thể bị suy giảm. Không bao giờ được làm cho các dấu hiệu cảnh báo trên dụng cụ đo không thể đọc được. **HÃY BẢO QUẢN CẨN THẬN CÁC HƯỚNG DẪN NÀY VÀ ĐƯA KÈM THEO KHI BẠN CHUYỂN GIAO DỤNG CỤ ĐO.**

- ▶ **Thận trọng** - nếu những thiết bị khác ngoài thiết bị hiệu chỉnh hoặc thiết bị điều khiển được nêu ở đây được sử dụng hoặc các phương pháp khác được tiến hành, có thể dẫn đến phơi nhiễm phóng xạ nguy hiểm.
- ▶ **Máy đo được dán nhãn cảnh báo laser** (được đánh dấu trong mô tả máy đo ở trang đồ thị).
- ▶ **Nếu văn bản của nhãn cảnh báo laser không theo ngôn ngữ của bạn, hãy dán chồng nhãn đính được cung cấp kèm theo bằng ngôn ngữ của nước bạn lên trên trước khi sử dụng lần đầu tiên.**



Không được hướng tia laze vào người hoặc động vật và không được nhìn vào tia laze trực tiếp hoặc phản xạ. Bởi vì bạn có thể chiếu lóa mắt người, gây tai nạn hoặc gây hỏng mắt.

- ▶ **Nếu tia laze hướng vào mắt, bạn phải nhắm mắt lại và ngay lập tức xoay đầu để tránh tia laze.**
- ▶ **Không thực hiện bất kỳ thay đổi nào ở thiết bị laser.**
- ▶ **Chỉ để người có chuyên môn được đào tạo sửa dụng cụ đo và chỉ dùng các phụ tùng gốc để sửa chữa.** Điều này đảm bảo cho sự an toàn của dụng cụ đo được giữ nguyên.
- ▶ **Không để trẻ em sử dụng dụng cụ đo laser khi không có người lớn giám sát.** Có thể vô tình làm lóa mắt người khác hoặc làm lóa mắt chính bản thân.
- ▶ **Không làm việc với dụng cụ đo trong môi trường dễ nổ, mà trong đó có chất lỏng, khí ga hoặc bụi dễ cháy.** Các tia lửa có thể hình thành trong dụng cụ đo và có khả năng làm rách cháy hay ngùn khói.
- ▶ **Không được tháo pin ra.** Nguy cơ bị chập mạch.
- ▶ **Trong trường hợp pin bị hỏng hay sử dụng sai cách, hơi nước có thể bốc ra. Pin có thể cháy hoặc nổ.** Hãy làm cho thông thoáng khí và trong trường hợp bị đau phải nhờ y tế chữa trị. Hơi nước có thể gây ngứa hệ hô hấp.
- ▶ **Khi sử dụng sai hoặc khi pin hỏng, dung dịch dễ cháy từ pin có thể tứa ra. Nếu vô tình chạm phải, hãy xối nước để rửa. Nếu dung dịch vào mắt, cần thêm sự hỗ trợ của y tế. Nếu chất lỏng dính vào mắt, yêu cầu ngay sự giúp đỡ của bác sĩ.** Dung dịch tiết ra từ pin có thể gây ngứa hay bỏng.
- ▶ **Pin có thể bị hư hại bởi các vật dụng nhọn như đinh hay tuốc-nơ-vít hoặc bởi các tác động lực từ bên ngoài.** Nó có thể dẫn tới đoản mạch nội bộ và làm pin bị cháy, bốc khói, phát nổ hoặc quá nóng.
- ▶ **Khi không sử dụng pin, để cách xa các vật bằng kim loại như kẹp giấy, tiền xu, chìa khoá, đinh, ốc vít hay các đồ vật kim loại nhỏ khác, thứ có thể tạo sự nối tiếp từ một đầu cực với một đầu cực khác.** Sự chập mạch của các đầu cực với nhau có thể gây bỏng hay cháy.
- ▶ **Chỉ sử dụng pin trong các sản phẩm của nhà sản xuất.** Chỉ bằng cách này, pin sẽ được bảo vệ tránh nguy cơ quá tải.
- ▶ **Chỉ được sạc pin lại với bộ nạp điện do nhà sản xuất chỉ định.** Một bộ nạp điện thích hợp cho một bộ pin nguồn có thể gây nguy cơ cháy khi sử dụng để nạp điện cho một bộ pin nguồn khác.



**Bảo vệ pin không để bị làm nóng, ví dụ, chống để lâu dài dưới ánh nắng gay gắt, lửa, chất bắn, nước, và sự ẩm ướt. Có nguy cơ nổ và chập mạch.**



- ▶ **Không sử dụng kính nhìn tia laser (Phụ kiện) làm kính bảo vệ.** Kính nhìn tia laser dùng để nhận biết tốt hơn tia laser; tuy nhiên kính không giúp bảo vệ mắt khỏi tia laser.
- ▶ **Không sử dụng kính nhìn tia laser (Phụ kiện) làm kính mát hoặc trong giao thông đường bộ.** Kính nhìn tia laser không chống UV hoàn toàn và giảm thiểu thụ cảm màu sắc.
- ▶ **Máy đo được trang bị một giao diện sóng vô tuyến.** Hãy chú ý các giới hạn địa điểm hoạt động ví dụ như trên máy bay hoặc bệnh viện.

Biểu tượng chữ *Bluetooth*® cũng như biểu tượng ảnh (các logo) do công ty cổ phần *Bluetooth SIG* đăng ký nhãn hiệu và sở hữu. Công ty trách nhiệm hữu hạn *Robert Bosch Power Tools GmbH* đã được cấp phép để sử dụng những biểu tượng chữ/biểu tượng ảnh này với sản phẩm của mình.

- ▶ **Cẩn thận!** Nếu sử dụng máy đo với cổng *Bluetooth*® có thể gây nhiễu các dụng cụ, thiết bị khác cũng như máy bay và dụng cụ y tế (ví dụ: máy tạo nhịp tim, máy trợ thính). Và cũng không thể loại trừ hoàn toàn những tổn hại cho người và động vật ở môi trường trực diện xung quanh. Không sử dụng máy đo có kết nối *Bluetooth*® ở gần những thiết bị y tế, trạm xăng, cơ sở hóa học, các khu vực có nguy cơ gây nổ và các khu vực cháy nổ. Không sử dụng máy đo có kết nối *Bluetooth*® trên máy bay. Tránh để máy hoạt động gần cơ thể trong thời gian dài.

## Hướng dẫn an toàn cho phích cắm điện tiếp hợp

- ▶ Phích cắm điện tiếp hợp này không thiết kế dành cho đối tượng sử dụng là trẻ em và người bị hạn chế về thể chất, khả năng giác quan kém hoặc tâm thần hoặc thiếu kinh nghiệm và thiếu hiểu biết. Phích cắm điện tiếp hợp này có thể dành cho trẻ em từ 8 tuổi trở lên và người bị hạn chế về thể chất, khả năng giác quan kém hoặc tâm thần hoặc thiếu kinh nghiệm và thiếu hiểu biết sử dụng, chỉ khi họ được một người chịu trách nhiệm cho sự an toàn của họ giám sát hoặc đã được người này hướng dẫn sử dụng keo dán khô trong môi trường

**an toàn và hiểu được những nguy hiểm có liên quan.** Nếu không sẽ có nguy cơ sai sót khi vận hành và gây thương tích.



**Không được để phích cắm điện tiếp hợp ngoài mưa hay ở tình trạng ẩm ướt.** Nước xâm nhập vào phích cắm điện tiếp hợp sẽ làm tăng nguy cơ điện giật.

- ▶ **Giữ sạch phích cắm điện tiếp hợp.** Có nguy cơ điện giật nếu bị bẩn.
- ▶ **Vui lòng kiểm tra trước khi sử dụng bộ nguồn phích cắm.** Không được sử dụng bộ nguồn phích cắm, nếu bạn phát hiện có hư hỏng. Không tự mở bộ nguồn phích cắm và chỉ cho phép Bosch hoặc trung tâm dịch vụ khách hàng được ủy quyền tiến hành sửa chữa với các phụ tùng gốc. Bộ nguồn phích cắm bị hỏng làm tăng nguy cơ bị điện giật.

## Mô Tả Sản Phẩm và Đặc Tính Kỹ Thuật

### Sử dụng đúng cách



Dụng cụ đo lường được thiết kế để đo độ xa, độ dài, chiều cao, khoảng cách, độ nghiêng và để tính toán diện tích và thể tích.

Dụng cụ đo thích hợp để sử dụng trong nhà.

Kết quả đo có thể được gửi qua *Bluetooth*® đến các thiết bị khác.

### Các bộ phận được minh họa

Sự đánh số các biểu trưng của sản phẩm là để tham khảo hình minh họa dụng cụ đo trong hình minh họa.

- (1)  Nút *Bluetooth*®
- (2)  Phím bấm chức năng
- (3)  Nút trù
- (4)  Hiển thị
- (5)  Nút đo
- (6)  Nút cộng
- (7)  Nút Các thiết lập ban đầu

- (8)  Nút Bật/Tắt/Quay lại
- (9) Nơi gắn dây đeo máy
- (10) Nhãn cảnh báo laser
- (11) Mã seri sản xuất
- (12) Lấy cài nắp đậy pin
- (13) Nắp đậy pin
- (14) 1/4"-Lỗ cắm giá ba chân
- (15) Thấu kính
- (16) Lỗ chiếu luồng laser
- (17) Vòng treo<sup>A)</sup>
- (18) Túi xách bảo vệ
- (19) Bộ pin Li-Ion<sup>A)</sup>
- (20) Khóa bộ pin Li-Ion<sup>A)</sup>
- (21) Cáp USB Type-C<sup>A)B)</sup>
- (22) Vỏ giắc cắm USB<sup>A)</sup>
- (23) Kẹp đai<sup>A)</sup>
- (24) Vít của kẹp đai<sup>A)</sup>
- (25) Giá đỡ ba chân<sup>A)</sup>
- (26) Bảng đích tia laser<sup>A)</sup>
- (27) Kính nhìn tia laser<sup>A)</sup>

A) Phụ tùng được trình bày hay mô tả không phải là một phần của tiêu chuẩn hàng hóa được giao kèm theo sản phẩm. Bạn có thể tham khảo tổng thể các loại phụ tùng, phụ kiện trong chương trình phụ tùng của chúng tôi.

B) USB kiểu C<sup>®</sup> và USB-C<sup>®</sup> là các thương hiệu của diễn đàn triển khai USB.

### Hiển thị các Phần tử

- (a) Điểm xuất phát đo chuẩn
- (b) Trạng thái *Bluetooth*<sup>®</sup>
  - ✦ *Bluetooth*<sup>®</sup> được kích hoạt, kết nối không được tạo

- ✦ *Bluetooth*<sup>®</sup> được kích hoạt, kết nối được tạo
- (c) Hiển thị pin
- (d) Các hàng giá trị đo được
- (e) Hàng kết quả
- (f) Hiển thị chức năng đo
- (g) Hiển thị góc nghiêng
- (h) Thanh trạng thái
- (i) Menu Các chức năng
- (j) Menu các thiết lập ban đầu
- (k) Menu các thiết lập ban đầu khác

## Thông số kỹ thuật

Máy đo khoảng cách laser	GLM 50-27 CG
Mã hàng	3 601 K72 U..
Phạm vi đo <sup>A)</sup>	0,05 – 50 m
Biên độ đo (trong điều kiện đo khó) <sup>B)</sup>	0,05 – 20 m
Sai số <sup>A)</sup>	±1,5 mm
Sai số (trong điều kiện đo khó) <sup>B)</sup>	±3,0 mm
Đơn vị biểu thị nhỏ nhất	0,5 mm
<b>Giới thiệu chung</b>	
Nhiệt độ hoạt động <sup>C)</sup>	-10 °C ... +45 °C
Nhiệt độ lưu kho	-20 °C ... +70 °C
Độ ẩm không khí tương đối tối đa.	90 %
Chiều cao ứng dụng tối đa qua chiều cao tham chiếu	2000 m
Mức độ bền theo IEC 61010-1	2 <sup>D)</sup>
Cấp độ laser	2
Loại laser	515 nm, < 1 mW
Phân kỳ tia laser	< 1,5 mrad (Góc đáy)
Tắt tự động sau khoảng	

<b>Máy đo khoảng cách laser</b>		<b>GLM 50-27 CG</b>
– Điểm laser		20 s
– Dụng cụ đo (khi không đo) <sup>E)</sup>		5 min
<b>Đo gián tiếp khoảng cách và bọt thủy</b>		
Phạm vi đo		0°–360° (4 × 90°)
<b>Đo độ dốc</b>		
Phạm vi đo		0°–360° (4 × 90°)
Sai số <sup>F)</sup> (G)		±0,2°
đơn vị biểu thị nhỏ nhất		0,1°
Trọng lượng theo Quy trình EPTA- Procedure 01:2014		0,17 kg
Mức độ bảo vệ	IP 65 (được bảo vệ chống bụi và tia nước)	
Kích thước		119 × 53 × 29 mm
Điều chỉnh đơn vị đo		m, ft, in
Bộ nguồn		2 × 1,5 V LR6 (AA)
<b>Bộ pin (Phụ kiện)</b>		<b>Li-Ion</b>
Chủng loại		BA 3.7V 1.0Ah A
Mã hàng		<b>1 607 A35 17H</b>
Cổng sạc USB		Type-C®
Điện thế danh định		3,7 V ---
Điện dung		1,0 Ah
Số lượng pin		1
Giới hạn của nhiệt độ nạp điện cho phép		+10 °C ... +35 °C
<b>Dây cắm điện</b>		
Điện áp ra		5,0 V ---
Dòng điện đầu ra tối thiểu		500 mA
<b>Truyền dữ liệu</b>		
Bluetooth®		Bluetooth® 4.2 (Low Energy) <sup>H)</sup>
Dải tần số hoạt động		2402–2480 MHz



**Máy đo khoảng cách laser****GLM 50-27 CG****Công suất phát tối đa****8 mW**

- A) Đo từ mép phía trước của dụng cụ đo, áp dụng cho mục tiêu có khả năng phản xạ cao (ví dụ như một bức tường sơn trắng), ánh sáng nền yếu và nhiệt độ làm việc là 20 °C; ngoài ra cần tính đến độ lệch  $\pm 0,05$  mm/m phụ thuộc khoảng cách.
- B) Đo từ mép phía trước của dụng cụ đo, áp dụng cho mục tiêu có khả năng phản xạ cao (ví dụ như một bức tường sơn trắng), ánh sáng nền, nhiệt độ làm việc là 20 °C và độ cao lớn; ngoài ra cần tính đến độ lệch  $\pm 0,15$  mm/m phụ thuộc khoảng cách.
- C) Trong chức năng Đo liên tục, nhiệt độ hoạt động tối đa là +40 °C.
- D) Chỉ có chất bán không dẫn xuất hiện, nhưng đôi khi độ dẫn điện tạm thời gây ra do ngưng tụ.
- E) *Bluetooth®* bị bỏ kích hoạt
- F) Ở nhiệt độ hoạt động 25 °C
- G) Sau khi hiệu chỉnh người dùng ở 0° và 90°; lỗi độ nghiêng bổ sung  $\pm 0,01$  °/độ đến 45° (tối đa) cần được lưu ý. Cảnh trái của dụng cụ đo được dùng làm mặt phẳng tham chiếu để đo độ nghiêng.
- H) Với các thiết bị *Bluetooth®* tiêu thụ năng lượng thấp, tùy thuộc vào model và hệ điều hành, có thể không cần các thiết lập kết nối. Các thiết bị *Bluetooth®* phải có tính năng hỗ trợ GATT profile.

Số xéri (11) đều được ghi trên nhãn mác, để dễ dàng nhận dạng loại máy đo.



## Lắp/thay bộ nguồn

Khuyến nghị nên sử dụng pin alkali-manganese hay pin Niken-kim loại hydroa (đặc biệt là ở nhiệt độ vận hành thấp) cho sự hoạt động của dụng cụ đo.

Pin 1,2-V có thể có khả năng đo nhiều hơn so với pin 1,5-V phụ thuộc vào điện dung.

» Mở nắp ngăn pin.

» Lắp pin/pin nạp lại được.

-  Luôn thay tất cả pin hoặc ắc quy cùng một lần. Chỉ sử dụng pin hoặc ắc quy cùng một hiệu và có cùng một điện dung.
-  Xin hãy lưu ý lắp tương ứng đúng cực pin như được thể hiện mặt trong ngăn chứa pin.

Khi mức sạc ắc quy hoặc pin thấp, trên màn hình xuất hiện truy vấn kích hoạt chế độ tiết kiệm pin. Khi kích hoạt chế độ tiết kiệm pin, thời gian chạy

pin sẽ được kéo dài và biểu tượng pin trên màn hình được đóng khung màu vàng. (xem „Bật/tắt chế độ tiết kiệm pin “, Trang 231)

Nếu biểu tượng pin cạn xuất hiện lần đầu tiên trên màn hình hiển thị, chỉ có thể thực hiện ít phép đo.

Khi biểu tượng pin rỗng và nhấp nháy màu đỏ, không thể thực hiện phép đo nữa. Thay pin hoặc sạc quy.

▶ **Tháo ắc quy hoặc pin ra khỏi dụng cụ đo nếu bạn không muốn sử dụng thiết bị trong thời gian dài.** Khi cất giữ pin trong một thời gian dài, pin/pin nạp lại được có thể bị ăn mòn và tự phóng điện.

 Cất giữ dụng cụ đo mà không có nắp dây pin được lắp **(13)** hoặc bộ pin Li-Ion **(19)** (Phụ kiện), đặc biệt là trong môi trường xung quanh bụi hoặc ẩm.

## Bộ pin Li-Ion (Phụ kiện)

### Lắp/thay bộ pin Li-Ion (Phụ kiện)

- » Lắp bộ pin Li-Ion **(19)** (Phụ kiện).
- » Để tháo bộ pin Li-Ion **(19)** (Phụ kiện) hãy nhấn khóa **(20)** và lấy bộ pin Li-Ion ra. (xem Hình minh họa . A, Trang 4)

### Sạc bộ pin Li-Ion (Phụ kiện)

▶ **Sử dụng bộ nguồn USB được khuyến nghị để sạc, mà điện áp đầu ra và dòng điện đầu ra tối thiểu theo yêu cầu trong chương "Dữ liệu kỹ thuật". Lưu ý hướng dẫn vận hành của bộ nguồn USB.**

Bộ nguồn được khuyến nghị: xem "Dữ liệu kỹ thuật".

▶ **Tuân thủ theo đúng điện thế!** Điện thế nguồn phải đúng với điện thế đã ghi rõ trên nhãn thông số của phích cắm điện tiếp hợp. Phích cắm điện tiếp hợp được ghi 230 V cũng có thể được vận hành ở 220 V.

 Các bộ pin Lithium-ion được giao một phần do các quy định vận tải quốc tế. Để bảo đảm đầy đủ điện dung, nạp điện hoàn toàn lại cho pin trước khi sử dụng cho lần đầu tiên.

Giắc nối USB để nối cáp USB **(21)** và đèn chỉ báo sạc ở bên dưới nắp của giắc nối USB **(22)** trên bộ pin Li-Ion **(19)** (Phụ kiện).

- » Mở nắp giắc nối USB **(22)**.

» Kết nối cáp USB (21).

Trong quá trình sạc, chỉ báo pin trên màn hình có thể khác với mức sạc thực tế của bộ pin Li-ion (19) (phụ kiện).

Trong khi sạc, đèn chỉ báo sạc sẽ chuyển sang màu vàng.

Nếu bộ pin Li-ion (19) (phụ kiện) được sạc đầy, đèn chỉ báo sạc sẽ sáng màu xanh lục.

Đèn chỉ báo sạc màu đỏ cho biết điện áp sạc hoặc dòng điện sạc không phù hợp.

## Vận Hành

### Bắt Đầu Vận Hành

- ▶ **Không cho phép dụng cụ đo đang bật một cách không kiểm soát và hãy tắt dụng cụ đo sau khi sử dụng.** Tia Laser có thể chiếu vào những người khác.
- ▶ **Bảo vệ dụng cụ đo tránh khỏi ẩm ướt và không để bức xạ mặt trời chiếu trực tiếp vào.**
- ▶ **Không cho dụng cụ đo tiếp xúc với nhiệt độ khác nghiệt hoặc dao động nhiệt độ.** Không để nó trong chế độ tự động quá lâu. Điều chỉnh nhiệt độ cho dụng cụ đo khi có sự dao động nhiệt độ lớn, trước khi bạn đưa nó vào vận hành. Trong trường hợp ở trạng thái nhiệt độ cực độ hay nhiệt độ thay đổi thái quá, sự chính xác của dụng cụ đo có thể bị hư hỏng.
- ▶ **Tránh va chạm mạnh hoặc làm rơi dụng cụ đo.** Sau khi có tác động mạnh từ bên ngoài lên dụng cụ đo, cần tiến hành kiểm tra độ chính xác trước khi tiếp tục (xem „Kiểm tra độ chính xác“, Trang 247).

### Bật Mở và Tắt

- » Bấm vào nút  để bật dụng cụ đo và laser.

Bạn cũng có thể bật dụng cụ đo mà không cần laser bằng cách nhấn nút .



- » Nhấn giữ nút  để tắt dụng cụ đo.

Các giá trị và các thiết lập thiết bị hiện có trong bộ nhớ sẽ được giữ lại.

## Quy trình đo

Sau khi bật lên lần đầu tiên, dụng cụ đo ở chế độ đo độ dài. Sau mỗi lần bật khác, dụng cụ đo sẽ ở chức năng đo đã sử dụng gần đây.

Có sẵn ba cài đặt cho mặt phẳng tham chiếu đo. (xem „Chọn mức tham chiếu“, Trang 229)

- » Đặt dụng cụ đo ở điểm đầu tiên muốn đo (ví dụ như bức tường).
- » Nếu bạn bật dụng cụ đo bằng nút , nhấn nhanh nút  để bật laser.
- » Nhấn vào nút  để kích hoạt đo.

Sau quá trình đo, chùm tia laser bị tắt. Đối với phép đo tiếp theo hãy lặp lại quy trình này.

Các giá trị đo hoặc kết quả cuối cùng có thể được cộng vào hoặc bị trừ.

Giá trị đo thường xuất hiện trong vòng 0,5 s và chậm nhất sau khoảng 4 s. Thời gian đo phụ thuộc vào độ xa, tình trạng ánh sáng và đặc tính phản xạ ánh sáng của bề mặt đối tượng. Sau quá trình đo, chùm tia laser bị tắt tự động.

 Không được di chuyển dụng cụ đo khi đang thực hiện phép đo (ngoài trừ ở chức năng đo liên tục và đo độ dốc). Do đó, hãy đặt dụng cụ đo trên một bề mặt chặn hoặc đỡ chắc chắn nếu có thể.

 Ống kính thu nhận (15) và đầu ra của tia laser (16) không được bị che khi đo.

### Ảnh hưởng đến khoảng đo

Khoảng đo phụ thuộc vào tình trạng ánh sáng và đặc tính phản xạ ánh sáng của bề mặt đối tượng.

Sử dụng kính ngắm laser (27) (phụ kiện) và bảng đích laser (26) (phụ kiện) hoặc che bề mặt đích để cải thiện độ rõ của tia laser.

### Ảnh hưởng đến kết quả đo



Do các tác động vật lý, không thể loại trừ trường hợp đo sai sẽ xảy ra khi đo trên các bề mặt khác nhau. Trong đó bao gồm:

- bề mặt trong suốt (ví dụ: thủy tinh, nước),
- bề mặt phản chiếu (ví dụ như kim loại được đánh bóng, thủy tinh),
- bề mặt rỗ (ví dụ vật liệu cách nhiệt),
- bề mặt có cấu trúc (ví dụ như thạch cao thô, đá tự nhiên).

Sử dụng bảng đích laser trên các bề mặt này nếu cần **(26)** (Phụ kiện).  
 Các phép đo không chính xác cũng có thể xảy ra trên các bề mặt đích được nhắm nghiêng.

Các lớp không khí có nhiệt độ khác nhau hoặc phản xạ nhận gián tiếp cũng có thể ảnh hưởng đến giá trị đo.

## Điều hướng trong menu

Trong menu bạn có thể chuyển sang phải bằng nút  và chuyển sang trái bằng nút .

Để xác nhận lựa chọn, hãy nhấn nút  hoặc nút .

Để thoát menu, hãy nhấn nút .

## Chọn mức tham chiếu

Để đo, bạn có thể chọn giữa các mức tham chiếu khác nhau:



mép trước của dụng cụ đo (ví dụ ví dụ khi áp dụng ở tường)



phần giữa của ren giá ba chân **(14)** (ví dụ khi đo bằng giá ba chân)



mép trước của dụng cụ đo (ví dụ khi đo từ một cạnh bàn)

» Nhấn nút  để mở menu **Cài đặt cơ bản**.

» Chọn .

» Sau đó dùng nút  hoặc nút  để chọn mặt phẳng tham chiếu mong muốn.











» Để xác nhận lựa chọn, hãy nhấn nút .







Sau mỗi lần bật dụng cụ đo, mặt phẳng tham chiếu đã chọn gần đây sẽ được thiết lập sẵn.

Sau đó không thể thay đổi mặt phẳng tham chiếu của các phép đo đã thực hiện (ví dụ khi hiển thị các giá trị đo trong danh sách giá trị đo).

## Menu các thiết lập ban đầu









Trong menu **các thiết lập ban đầu** hãy tham khảo các thiết lập ban đầu:

-  Thay đổi mức tham chiếu (xem „Chọn mức tham chiếu“, Trang 229)
-  Bật/tắt tín hiệu âm thanh
-  Bật/tắt rung
-  Cài đặt độ sáng màn hình
-  Bật/tắt chế độ tiết kiệm pin
-  Thay Đổi Đơn Vị Đo Lường
-  Cài đặt ngôn ngữ
-  Hiệu chuẩn đo độ dốc (xem „Kiểm tra độ chính xác“, Trang 247)
-  Mở thông tin về thiết bị
-  Cài đặt của nhà máy
-  Xóa bộ nhớ

- » Nhấn nút  để mở menu **Cài đặt cơ bản**.
- » Hãy chọn cài đặt mong muốn bằng nút  hoặc nút .
- » Để xác nhận lựa chọn, hãy nhấn nút  hoặc nút .
- » Để thoát menu **cài đặt cơ bản**, nhấn nhanh nút .

### Bật/tắt tín hiệu âm thanh









Bật âm thanh trong cài đặt cơ sở.

- » Nhấn nút  để mở menu **Cài đặt cơ bản** .
  - » Chọn .
  - » Để thay đổi lựa chọn, hãy nhấn nút  hoặc nút .
  - » Để xác nhận lựa chọn, hãy nhấn nút  hoặc nút .
  - » Để thoát menu **Cài đặt cơ bản** , nhấn nhanh nút .
- Sau khi tắt dụng cụ đo, thiết lập đã chọn sẽ được lưu lại.

### Bật/tắt rung









Bật rung trong cài đặt cơ bản.

Rung của dụng cụ đo có thể là sự hỗ trợ hữu ích khi có tiếng ồn lớn xung quanh. Hai rung động ngắn báo hiệu một phép đo thành công; một rung động dài cho biết một phép đo không chính xác.

- » Nhấn nút  để mở menu **Cài đặt cơ bản** .
  - » Chọn .
  - » Để thay đổi lựa chọn, hãy nhấn nút  hoặc nút .
  - » Để xác nhận lựa chọn, hãy nhấn nút  hoặc nút .
  - » Để thoát menu **Cài đặt cơ bản** , nhấn nhanh nút .
- Sau khi tắt dụng cụ đo, thiết lập đã chọn sẽ được lưu lại.



### Cài đặt độ sáng màn hình







Độ sáng của màn hình hiển thị được điều chỉnh theo nhiều mức phù hợp với các điều kiện xung quanh.

- » Nhấn nút  để mở menu **Cài đặt cơ bản** .
  - » Chọn .
  - » Để thay đổi lựa chọn, hãy nhấn nút  hoặc nút .
  - » Để xác nhận lựa chọn, hãy nhấn nút  hoặc nút .
  - » Để thoát menu **Cài đặt cơ bản** , nhấn nhanh nút .
- Sau khi tắt dụng cụ đo, thiết lập đã chọn sẽ được lưu lại.

### Bật/tắt chế độ tiết kiệm pin









Chế độ tiết kiệm pin được tắt trong cài đặt cơ bản. Khi bật chế độ tiết kiệm pin, âm thanh và rung sẽ bị bỏ kích hoạt và độ sáng màn hình giảm. Điều này sẽ kéo dài thời gian chạy pin.

- » Nhấn nút  để mở menu **Cài đặt cơ bản** .
- » Chọn .

- » Để thay đổi lựa chọn, hãy nhấn nút  hoặc nút .
  - » Để xác nhận lựa chọn, hãy nhấn nút  hoặc nút .
  - » Để thoát menu **Cài đặt cơ bản** , nhấn nhanh nút .
- Sau khi tắt dụng cụ đo, thiết lập đã chọn sẽ được lưu lại.

### Thay Đổi Đơn Vị Đo Lường











Thiết lập ban đầu là đơn vị đo „m“ (Mét). Có sáu đơn vị đo lường khác nhau. Đặt đơn vị đo phù hợp cho mục đích của bạn.

- » Nhấn nút  để mở menu **Cài đặt cơ bản** .
  - » Chọn .
  - » Để thay đổi lựa chọn, hãy nhấn nút  hoặc nút .
  - » Để xác nhận lựa chọn, hãy nhấn nút  hoặc nút .
  - » Để thoát menu **Cài đặt cơ bản** , nhấn nhanh nút .
- Sau khi tắt dụng cụ đo, thiết lập đã chọn sẽ được lưu lại.

### Cài đặt ngôn ngữ

Khi bật dụng cụ đo lần đầu tiên, bạn sẽ được yêu cầu đặt ngôn ngữ ưa tiên cho văn bản hiển thị.





Bạn có thể thay đổi ngôn ngữ đã cài đặt bất cứ lúc nào.

- » Nhấn nút  để mở menu **Cài đặt cơ bản** .
  - » Chọn  cho các cài đặt khác.
  - » Chọn .
  - » Để thay đổi lựa chọn, hãy nhấn nút  hoặc nút .
  - » Để xác nhận lựa chọn, hãy nhấn nút  hoặc nút .
  - » Để thoát menu **Cài đặt cơ bản** , nhấn nhanh nút .
- Sau khi tắt dụng cụ đo, thiết lập đã chọn sẽ được lưu lại.











### Thông tin về thiết bị

Hãy tham khảo các thông tin về dụng cụ đo tại đây ví dụ số seri, phiên bản phần mềm và giấy phép.









- » Nhấn nút  để mở menu **Cài đặt cơ bản** .
- » Chọn **...** cho các cài đặt khác.
- » Chọn **i**.
- » Để thoát menu **Cài đặt cơ bản** , nhấn nhanh nút .

### Khôi phục cài đặt gốc

Chức năng này dùng để thiết lập lại dụng cụ đo về cài đặt xuất xưởng/cài đặt cơ bản. Sau khi thiết lập lại, bạn được yêu cầu đặt ngôn ngữ ưa tiên cho màn hình hiển thị.

- » Nhấn nút  để mở menu **Cài đặt cơ bản** .
- » Chọn **...** cho các cài đặt khác.
- » Chọn .
- » Để thiết lập lại dụng cụ đo, chọn  và xác nhận bằng nút  hoặc nút .
- » Để thoát menu **Cài đặt cơ bản** , nhấn nhanh nút .













### Xóa bộ nhớ

- » Nhấn nút  để mở menu **Cài đặt cơ bản** .
  - » Chọn **...** cho các cài đặt khác.
  - » Chọn .
  - » Để xóa bộ nhớ, hãy chọn  bằng nút  hoặc nút  và xác nhận bằng nút  hoặc nút .
- Tất cả giá trị đo được xóa.



## Các chức năng đo

### Chọn/thay đổi các chức năng đo

Trong menu chức năng hãy tìm các chức năng sau đây:

-  Đo Chiều Dài
-  Đo liên tục
-  Đo Diện Tích
-  Đo khối lượng
-  đo khoảng cách gián tiếp
  -  đo chiều cao gián tiếp
  -  đo chiều cao gián tiếp kép
  -  đo chiều dài gián tiếp
-  Đo diện tích tường
-  Đo chia khoảng
-  Đo độ dốc/Ổng bọt nước kỹ thuật số
-  Chức năng bộ nhớ

» Nhấn nút  để mở menu **Các chức năng**.

» Hãy chọn chức năng đo mong muốn bằng nút  hoặc nút .

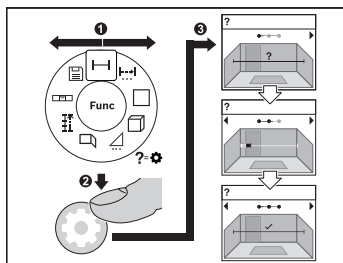

» Để xác nhận lựa chọn, hãy nhấn nút  hoặc nút .

### Chức năng trợ giúp tích hợp ?



Chức năng trợ giúp tích hợp trong dụng cụ đo cung cấp hoạt ảnh chi tiết về tất cả chức năng đo/quá trình đo.





» Mở menu **các chức năng**.

» Hãy chọn chức năng mong muốn bằng nút  hoặc nút  và nhấn nút .

Hoạt ảnh với biện pháp chi tiết về chức năng đo đã chọn được hiển thị.

» Nhấn nút  hoặc  để hiển thị bước tiếp theo hoặc bước trước.

### Đo Chiều Dài

- » Nhấn nút  để mở menu **Các chức năng**.
- » Chọn đo chiều dài  và xác nhận lựa chọn bằng nút .
- » Nhấn nhanh nút  để bật laser.
- » Nhấn vào nút  để kích hoạt đo.





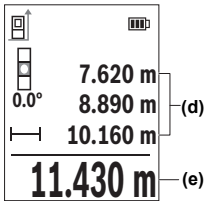

Giá trị đo được hiển thị bên dưới trong màn hình ở dòng kết quả **(e)**.

» Lặp lại bước trên với mỗi phép đo tiếp theo.



Với nhiều phép đo chiều dài liên tiếp, kết quả của phép đo cuối được hiển thị trong dòng giá trị đo **(d)**. Giá trị đo cuối cùng sẽ hiện ở góc dưới trong màn hình hiển thị, giá trị đo áp chốt như trên.

### Đo Diện Tích

- » Nhấn nút  để mở menu **Các chức năng**.
- » Chọn đo diện tích  và xác nhận lựa chọn bằng nút .
- » Nhấn nhanh nút  để bật laser.
- » Nhấn vào nút  để kích hoạt phép đo đầu tiên, ví dụ chiều dài của phòng.
- » Nhấn vào nút  để kích hoạt phép đo thứ hai, ví dụ chiều rộng của phòng.

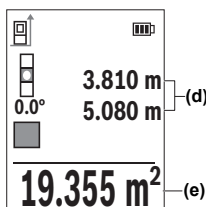

Sau khi kết thúc lần đo thứ hai phần diện tích sẽ được tính và hiển thị tự động. Kết quả được hiển thị trong dòng kết quả (e). Giá trị đo riêng biệt ở trong các dòng giá trị đo được (d).

### Đo liên tục



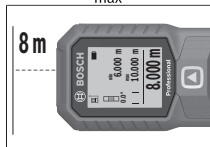

Khi đo liên tục, giá trị đo được cập nhật liên tục. Ví dụ bạn có thể đứng cách tường tới khoảng cách mong muốn, khoảng cách hiện tại luôn dễ đọc.

Có sẵn ba chức năng để đo liên tục, mỗi chức năng hiển thị phép đo theo cách khác trên màn hình:

#### min/max



Giá trị đo nhỏ nhất và lớn nhất được hiển thị liên tục trên màn hình.

- » Nhấn nút  để mở menu **Các chức năng**.
- » Chọn min/max  trong mục menu Đo liên tục  và xác nhận lựa chọn bằng nút .

- » Nhấn nhanh nút  để bật laser.
- » Di chuyển dụng cụ đo cho đến khi khoảng cách mong muốn được hiển thị trong dòng kết quả.

Bạn có thể ngưng đo liên tục, bằng cách nhấn nhanh nút .

- » Nhấn lại nút  để tiếp tục đo liên tục.

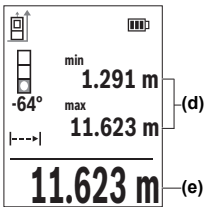

Giá trị đo hiện tại được hiển thị trong dòng kết quả (e) giá trị đo tối đa và tối thiểu trong dòng giá trị đo (d).

### số lượng lớn 0<sup>+</sup>

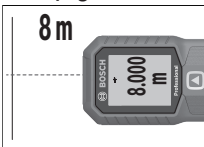

Giá trị đo được hiển thị phóng to để dễ đọc hơn.

### Thước dây

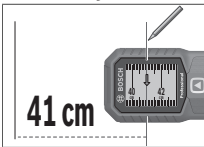



Khoảng cách được hiển thị trực quan như ở thước dây.

(i) Trong chức năng thước dây, mức tham chiếu là đánh dấu được hiển thị trong màn hình. Mức tham chiếu không phải là cạnh của dụng cụ đo.

Phép đo liên tục được tự động tắt sau 4 phút.

### Đo khối lượng

- » Nhấn nút **Func** để mở menu **Các chức năng**.
- » Chọn đo thể tích  và xác nhận lựa chọn bằng nút **Func**.
- » Nhấn nhanh nút  để bật laser.

- » Nhấn vào nút ▲ để kích hoạt phép đo đầu tiên, ví dụ chiều dài của phòng.
- » Nhấn vào nút ▲ để kích hoạt phép đo thứ hai, ví dụ chiều rộng của phòng.
- » Nhấn vào nút ▲ để kích hoạt phép đo thứ ba, ví dụ chiều cao của phòng.

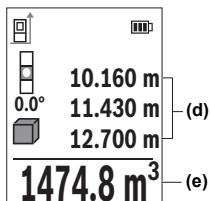

Sau khi thực hiện việc đo lần thứ ba, khối lượng được tự động tính toán và hiển thị. Kết quả được hiển thị trong dòng kết quả (e). Giá trị đo riêng biệt ở trong các dòng giá trị đo được (d).

### Đo Gián Tiếp Khoảng Cách



Đo gián tiếp khoảng cách được sử dụng để đo khoảng cách mà ta không thể đo trực tiếp được do có vật cản trở ngăn cản luồng laze, hoặc do không có bề mặt mục tiêu sẵn có nào được sử dụng như là vật phản chiếu. Quy trình đo này chỉ có thể sử dụng trong chiều thẳng đứng. Bất cứ sự lệch hướng nào ở chiều ngang cũng sẽ gây ra sự sai.

Việc đo khoảng cách gián tiếp sẽ luôn đưa kết quả không chính xác bằng việc đo trực tiếp. Tùy các điều kiện áp dụng, xác suất lỗi đo có thể lớn hơn khi đo khoảng cách trực tiếp. Để cải thiện độ chính xác trong khi đo, nên sử dụng giá đỡ ba chân (phụ tùng).

 Khi sử dụng giá ba chân hãy lưu ý mức tham chiếu đã cài đặt. (xem „Chọn mức tham chiếu“, Trang 229)

Luồng laze duy trì ở trạng thái mở giữa các lần đo riêng lẻ.

Đối với việc đo gián tiếp chiều dài, có 3 chế độ đo để ứng dụng, mỗi chế độ đo có thể sử dụng để xác định các khoảng cách khác nhau:

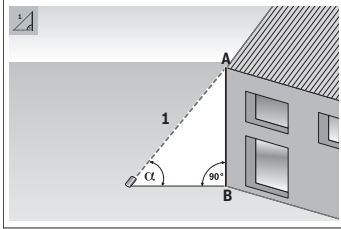

-  đo chiều cao gián tiếp
-  đo chiều cao gián tiếp kép
-  đo chiều dài gián tiếp

### Đo chiều cao gián tiếp



Với đo chiều cao gián tiếp, bạn có thể xác định quãng đường **AB** bằng cách đo quãng đường **1**. Dụng cụ đo tính toàn chiều cao đã đo **AB** từ góc  $\alpha$  và quãng đường **1**.

Chỉ có thể đạt được kết quả chính xác, nếu góc bên phải được yêu cầu khi đo tương ứng được tuân thủ chính xác.

- » Nhấn nút **Func** để mở menu **Các chức năng**.
- » Chọn phép đo khoảng cách gián tiếp  và xác nhận lựa chọn bằng nút **Func**.
- » Chọn phép đo chiều cao gián tiếp  và xác nhận lựa chọn bằng nút **Func**.
- » Nhấn nhanh nút **▲** để bật laser.
- » Đặt dụng cụ đo ngang tầm của điểm đo dưới **B**.
- » Nghiêng dụng cụ đo sao cho laser hướng về điểm đo trên **A**.
- » Nhấn vào nút **▲** để kích hoạt đo.





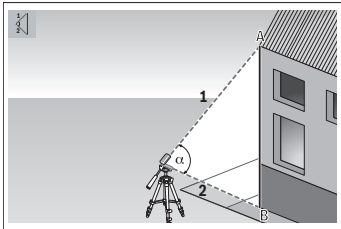



Sau khi kết thúc phép đo, chiều cao sẽ được tính và hiển thị tự động trong dòng kết quả **(e)**. Giá trị đo của đoạn đường „1“ và góc  $\alpha$  ở trong các hàng giá trị đo được **(d)**.

### Đo chiều cao gián tiếp kép









Với đo chiều cao gián tiếp kép, bạn có thể xác định quãng đường **AB** bằng cách đo quãng đường **1** và **2**. Dụng cụ đo tính toàn chiều cao đã đo **AB** từ góc  $\alpha$  và quãng đường **1** và **2**.

Khuyến nghị sử dụng giá ba chân cho phép đo này.

- » Nhấn nút  để mở menu **Các chức năng**.
- » Chọn phép đo khoảng cách gián tiếp  và xác nhận lựa chọn bằng nút .
- » Chọn phép đo chiều cao gián tiếp kép  và xác nhận lựa chọn bằng nút .
- » Nhấn nhanh nút  để bật laser.
- » Nghiêng dụng cụ đo sao cho laser hướng về điểm đo trên **A**.
- » Nhấn vào nút  để kích hoạt phép đo đầu tiên.
- » Nghiêng dụng cụ đo sao cho laser hướng về điểm đo dưới **B**. Khi đó, không thay đổi vị trí của dụng cụ đo.
- » Nhấn vào nút  để kích hoạt phép đo thứ hai.

Sau khi kết thúc phép đo, chiều cao sẽ được tính và hiển thị tự động trong dòng kết quả **(e)**. Giá trị đo của đoạn đường **1, 2** và góc  $\alpha$  ở trong các hàng giá trị đo được **(d)**.

### Đo chiều dài gián tiếp

- » Nhấn nút  để mở menu **Các chức năng**.
- » Chọn phép đo khoảng cách gián tiếp  và xác nhận lựa chọn bằng nút .
- » Chọn phép đo chiều dài gián tiếp  và xác nhận lựa chọn bằng nút .
- » Hãy đặt dụng cụ đo trên điểm khởi đầu **A** của quãng đường **AB**.
- » Nghiêng dụng cụ đo sao cho laser hướng về mặt phẳng mà trên đó có điểm cuối **B**.
- » Nhấn vào nút  để kích hoạt đo.



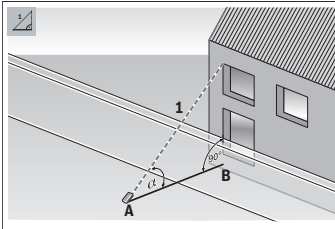

Với đo chiều dài gián tiếp, bạn có thể xác định quãng đường **AB** bằng cách đo quãng đường **1**. Dụng cụ đo tính toàn chiều dài đã dò **AB** từ góc  $\alpha$  và quãng đường **1**.

Sau khi kết thúc phép đo, chiều dài sẽ được tính và hiển thị tự động trong dòng kết quả **(e)**. Giá trị đo của đoạn đường „1“ và góc  $\alpha$  ở trong các hàng giá trị đo được **(d)**.

### Đo diện tích tường

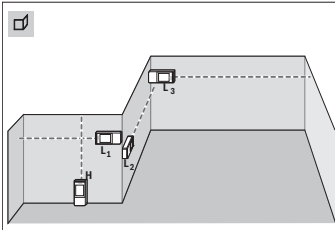



Đo bề mặt tường được sử dụng để xác định tổng số của một số bề mặt riêng lẻ có cùng một chiều cao. Điều kiện để tính toán đúng diện tích, là chiều dài đã đo đầu tiên (trong ví dụ chiều cao phòng **H**) phải đồng nhất đối với tất cả các phần diện tích.

Trong ví dụ minh họa, tổng diện tích của nhiều bức tường được xác định, trong đó có chiều cao phòng giống

nhau **H**, nhưng các chiều dài khác nhau **L**.

» Nhấn nút  để mở menu **Các chức năng**.

» Chọn đo diện tích tường  và xác nhận lựa chọn bằng nút .

» Đo chiều cao phòng **H** như đo chiều dài.

Giá trị đo được hiển thị trong dòng giá trị đo phía trên. Laser vẫn bật.

» Sau đó đo chiều dài **L1** của bức tường thứ nhất.

Diện tích được tính toán tự động và được hiển thị trong dòng kết quả. Giá trị đo chiều dài cuối cùng xuất hiện ở dòng giá trị đo dưới. Laser vẫn bật.

» Đo chiều dài **L2** của bức tường thứ hai.

Bạn có thể tùy ý đo nhiều chiều dài tiếp theo **LX** mà tự động được cộng thêm vào và được nhân với chiều cao **H**.

Đơn vị đo hiển thị trong dòng giá trị đo (**d**) sẽ được cộng thêm vào chiều dài **L1**. Tổng hai chiều dài (được hiển thị trong dòng giá trị đo ở giữa (**d**)) sẽ được nhân với chiều cao đã lưu **H**. Tổng giá trị diện tích được hiển thị trong dòng kết quả (**e**) bên dưới ở màn hình.

### Đo chia khoảng

- i** Trong đo chia khoảng, mức tham chiếu là đánh dấu được hiển thị trong màn hình. Mức tham chiếu không phải là cạnh của dụng cụ đo.

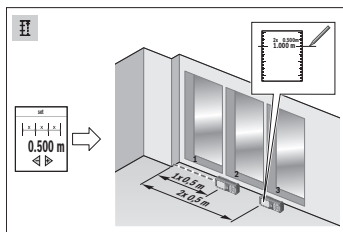

Chức năng khoan cọc sẽ đo lại nhiều lần chiều dài xác định (khoảng cách). Những chiều dài này có thể được chuyển thành bê mặt, để cho phép cắt nguyên liệu thành miếng dài bằng nhau hoặc tạo các tường ngăn phụ dạng vách thạch cao. Chiều dài tối thiểu có thể thiết lập là 0,1 m, chiều dài tối đa là 50 m.

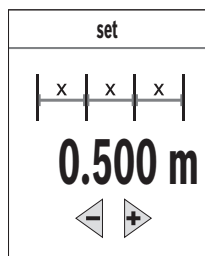

- » Nhấn nút **Func** để mở menu **Các chức năng**.
- » Chọn chức năng đo chia khoảng  và xác nhận lựa chọn bằng nút **Func**.
- » Thiết lập chiều dài mong muốn bằng nút **▶** hoặc nút **◀**  
Để thay đổi chiều dài trong các bước lớn hơn, hãy nhấn nút **▶** hoặc nút **◀**.
- » Nhấn nút **▲** để khởi động chức năng đo chia

khoảng và ra khỏi điểm khởi đầu một cách từ từ.

Dụng cụ đo tiếp tục đo khoảng cách tới điểm khởi đầu. Khi đó chiều dài xác định cũng như giá trị đo hiện tại sẽ được hiển thị. Các mũi tên trên và dưới cho thấy khoảng cách nhỏ nhất đến ký hiệu đánh dấu kế tiếp hoặc trước đó.

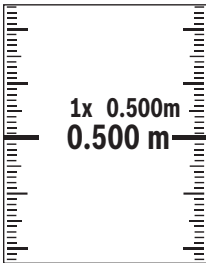

Hệ số bên trái chỉ ra chiều dài xác định đã đạt được bao nhiêu lần. Các dòng màu xanh lá ở hai bên của màn hình hiển thị cho biết chiều dài đạt được cho mục đích đánh dấu.

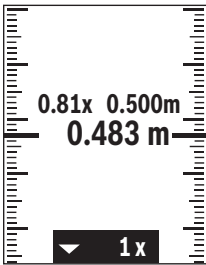

Các dòng màu xanh dương và nhân màu xanh dương hiển thị giá trị thực, nếu giá trị chuẩn nằm ngoài màn hình hiển thị.

### Đo độ dốc/Ổng bọt nước kỹ thuật số

Ổng bọt nước kỹ thuật số được sử dụng để kiểm tra các hướng nằm ngang hoặc thẳng đứng của một đối tượng (ví dụ như máy giặt, tủ lạnh, vv). Đo độ nghiêng được sử dụng để đo độ dốc hoặc độ nghiêng (ví dụ như cầu thang, tay vịn cầu thang, khi khớp các đồ gỗ, khi lắp đặt ống, vv). Dụng cụ đo tự động chuyển đổi giữa hai chức năng, nếu bạn thay đổi vị trí dụng cụ đo.

- » Nhấn nút để mở menu **Các chức năng**.
- » Chọn đo độ nghiêng/ổng bọt nước kỹ thuật số và xác nhận lựa chọn bằng nút .

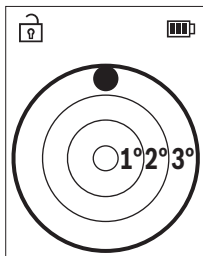

Cạnh dưới của dụng cụ đo được dùng làm mức tham chiếu cho ống bọt nước kỹ thuật số.

- » Hãy sử dụng ống bọt nước kỹ thuật số, đặt dụng cụ đo với mặt sau lên bề mặt cần đo. Bạn có thể đóng băng giá trị đo bằng cách nhấn nút ▲.
- » Khi độ nghiêng 3° bị vượt quá, hình cầu trong màn hình hiển thị chiếu sáng màu đỏ.

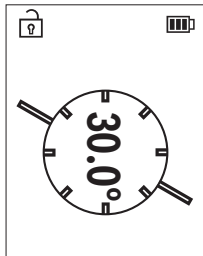





Cạnh trái của dụng cụ đo được dùng làm mặt phẳng tham chiếu để đo độ nghiêng. Khi chỉ thị báo sáng lên trong quá trình đo là do dụng cụ đo bị kéo nghiêng quá nhiều ở chiều bên kia.

- » Để sử dụng phép đo độ nghiêng, đặt dụng cụ đo với mặt bên lên vật thể có độ nghiêng bạn muốn đo. Bạn có thể đóng băng giá trị đo bằng cách nhấn nút ▲.

## Chức năng bộ nhớ



Giá trị hoặc kết quả cuối cùng của mỗi lần đo xong sẽ được lưu trữ tự động. Các giá trị cuối **30** (Giá trị đo hoặc kết quả cuối) được lưu lại. Nếu bộ nhớ đầy, giá trị cũ nhất bị ghi đè. Phép đo cũ nhất được lưu ở vị trí số 1 trong bộ nhớ, phép đo gần đây nhất được lưu ở vị trí **30** (với **30** giá trị có thể được lưu).

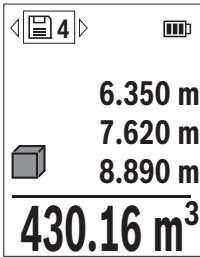

- » Nhấn nút  để mở menu **Các chức năng**.
- » Chọn chức năng bộ nhớ  và xác nhận lựa chọn bằng nút . Giá trị cuối được hiển thị.
- » Nhấn nút  hoặc nút  để lật thông qua các giá trị đã lưu.



Số giá trị đã lưu được hiển thị ở phía trên của màn hình và phía bên trái là biểu tượng của chức năng đo tương ứng. Nếu không có phép đo nào được lưu trong bộ nhớ, phía dưới của màn hình hiển thị „0.000“ và phía trên hiển thị „0“.

### Xóa giá trị bộ nhớ

- » Để xóa giá trị đã hiển thị, hãy nhấn nút .
- » Hãy xác nhận bằng nút .

Để xóa tất cả giá trị đã lưu, trong menu **thiết lập ban đầu** hãy chọn  mục menu **xóa bộ nhớ**. (xem „Xóa bộ nhớ “, Trang 233)

## Cộng/trừ các giá trị

### Thêm giá trị khi đo chiều dài

- » Hãy chọn chức năng đo chiều dài.
- » Tiến hành phép đo đầu tiên.
- » Nhấn nút .
- » Tiến hành phép đo thứ hai.

Ngay khi phép đo thứ hai hoàn thành, kết quả của phép đo thứ hai được hiển thị trong dòng giá trị đo **(d)** và kết quả được hiển thị trong dòng kết quả **(e)**.

### Thêm giá trị khi đo diện tích và thể tích

- » Chọn chức năng đo diện tích hoặc thể tích.
- » Tiến hành phép đo diện tích đầu tiên của phép đo thể tích.
- » Nhấn nút .

» Tiến hành phép đo diện tích thứ hai của phép đo thể tích.

Ngay khi phép đo thứ hai hoặc thứ ba kết thúc, diện tích hoặc thể tích được tính và hiển thị tự động. Kết quả được hiển thị trong dòng kết quả (e). Giá trị đo riêng biệt ở trong các dòng giá trị đo được (d).

» Nhấn nút ▲ để hiển thị kết quả cuối của phần bố sung.

Kết quả cuối được hiển thị trong dòng kết quả (e). Các kết quả của phép đo diện tích hoặc thể tích ở trong dòng giá trị đo (d).

### Trừ các giá trị

» Để trừ các giá trị hãy nhấn nút ◀. Quy trình tiếp theo tương tự như "Cộng các giá trị".

### Xoá giá trị đo

Bạn có thể xóa giá trị đo xác định cuối trong tất cả chức năng đo bằng cách nhấn nhanh nút Ⓞ.

Bằng việc nhấn nhanh nhiều lần nút Ⓞ các kết quả đo sẽ được xóa theo thứ tự ngược.

### Giao diện *Bluetooth*®

#### Truyền dữ liệu sang các thiết bị khác

Máy đo được trang bị một mô-đun *Bluetooth*® bằng kỹ thuật sóng vô tuyến cho phép truyền dữ liệu tới các thiết bị di động đầu cuối với giao diện *Bluetooth*® (ví dụ điện thoại thông minh, máy tính bảng).



Các thông tin về điều kiện hệ thống cần thiết cho việc kết nối *Bluetooth*® có thể tìm thấy trên trang Web của Bosch theo địa chỉ [www.bosch-pt.com](http://www.bosch-pt.com).

#### ► Thông tin tiếp theo xin vui lòng tìm trên trang sản phẩm Bosch.

Khi truyền dữ liệu bằng *Bluetooth*® có thể sẽ xuất hiện thời gian ngưng (time delay) giữa thiết bị di động đầu cuối và máy đo. Điều này có thể là do khoảng cách giữa cả hai thiết bị hoặc do chính đối tượng đo.

#### Kích hoạt giao diện *Bluetooth*® để truyền dữ liệu tới một thiết bị di động đầu cuối

✓ Hãy chắc chắn rằng, giao diện *Bluetooth*® trên thiết bị di động đầu cuối của bạn đã được kích hoạt.

- » Nhấn nút  để mở menu *Bluetooth®*.
- » Nhấn lại nút  để kích hoạt giao diện *Bluetooth®*.

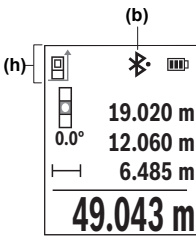



Trạng thái kết nối cũng như kết nối đang hoạt động **(b)** sẽ được hiển thị trong thanh trạng thái **(h)** của dụng cụ đo.

Các ứng dụng Bosch có sẵn để mở rộng phạm vi chức năng. Bạn có thể tải nó tùy theo thiết bị đầu cuối trong kho ứng dụng tương ứng.

Sau khi khởi động ứng dụng Bosch, hãy thiết lập kết nối giữa thiết bị đầu cuối và máy đo. Nếu phát hiện nhiều dụng cụ đo đã kích hoạt, hãy chọn dụng cụ đo phù hợp dựa theo số seri. Số seri **(11)** bạn hãy tìm trên nhãn thông tin nhận dạng dụng cụ đo.

### Bỏ kích hoạt giao diện *Bluetooth®*



- » Nhấn nút , để mở menu *Bluetooth®*, và nhấn lại nút , để bỏ kích hoạt giao diện *Bluetooth®*.

### Kiểm tra độ chính xác

Thường xuyên kiểm tra độ chính xác của đo độ dốc và đo khoảng cách.

#### Kiểm tra độ chính xác và hiệu chỉnh đo độ dốc

- » Hãy đặt dụng cụ đo lên bàn và đo độ dốc.
- » Hãy xoay dụng cụ đo 180° và đo lại độ dốc.  
Độ sai khác của giá trị được hiển thị tối đa là 0,3°.  
Đối với độ sai lệch lớn hơn bạn phải hiệu chuẩn lại dụng cụ đo.

- » Nhấn nút  để mở menu **Cài đặt cơ bản**.
- » Chọn  và xác nhận lựa chọn bằng nút .
- » Làm theo các hướng dẫn trên màn hình hiển thị.

 Sau những thay đổi mạnh về nhiệt độ và sau những sự va chạm, cần phải kiểm độ chính xác và nếu có thể hãy hiệu chỉnh máy. Sau khi có

sự thay đổi về nhiệt độ máy đo phải được giảm nhiệt/làm mát trong thời gian nhất định trước khi hiệu chỉnh.

### Kiểm tra độ chính xác của việc đo khoảng cách

Để kiểm tra độ chính xác, phép đo phải được thực hiện trong điều kiện thuận lợi, tức là khoảng cách đo phải ở trong phòng và bề mặt đối tượng của phép đo phải trơn nhẵn đồng thời có độ phản xạ tốt (ví dụ tường có vạch trắng).

» Chọn quãng đo, **3 đến 10 m**, chiều dài của khu vực này phải được biết rõ chính xác (vd. chiều rộng của một căn phòng hay một khung cửa).

» Đo khoảng cách 10 lần liên tiếp.

Sai lệch của các phép đo riêng biệt so với kích thước chính xác được vượt quá  $\pm 2$  mm tổng khoảng cách đo trong điều kiện thuận lợi. Ghi lại các phép đo để sau này có thể so sánh độ chính xác của các phép đo.

### Sử dụng giá đỡ ba chân (phụ kiện)

Sử dụng giá ba chân là đặc biệt hữu ích cho khoảng cách lớn.

» Hãy đặt máy đo có ren 1/4" (**14**) lên đĩa nhả hãm nhanh của giá ba chân (**25**) hoặc một chiếc giá ba chân của máy ảnh thông thường.

» Vặn ốc máy đo bằng vít định vị của đĩa nhả hãm nhanh thật chặt.

» Hãy cài đặt mặt phẳng tham chiếu cho các phép đo bằng giá đỡ ba chân. (xem „Chọn mức tham chiếu“, Trang 229)



## Kẹp đai

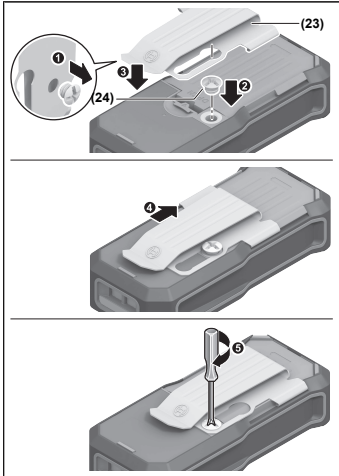

Bằng kẹp đai (23) bạn có thể móc dụng cụ đo dễ dàng vào đai.

Để gắn kẹp đai vào dụng cụ đo, hãy làm theo các bước trong hình minh họa.

## Thông báo lỗi

Khi phép đo đúng không thực hiện được, thông báo lỗi **Error** sẽ được hiển thị trong màn hình hiển thị.

- » Thử thực hiện lại quá trình đo.
- » Nếu thông báo lỗi lại xuất hiện, hãy tắt và bật lại dụng cụ đo và bắt đầu lại phép đo.



Dụng cụ đo kiểm soát độ chính xác của mỗi phép đo. Nếu lỗi được phát hiện, màn hình chỉ hiển thị biểu tượng bên cạnh, và dụng cụ đo được ngắt. Trong trường hợp này, hãy chuyển dụng cụ đo đến bộ phận dịch vụ khách hàng của Bosch thông qua đại lý bán hàng của bạn.

## Bảo Dưỡng và Bảo Quản

### Bảo Dưỡng Và Làm Sạch

Chỉ được cất giữ và vận chuyển dụng cụ đo trong túi xách bảo vệ được giao kèm.

Luôn luôn giữ cho dụng cụ đo thật sạch sẽ.

Không được nhúng dụng cụ đo vào trong nước hay các chất lỏng khác.

Lau sạch bụi bẩn bằng một mảnh vải mềm và ẩm. Không được sử dụng chất tẩy rửa.

Chăm sóc thấu kính (15) một cách cẩn thận giống như khi xử lý kính hoặc ống kính máy ảnh.

Trong trường hợp cần sửa chữa, hãy gửi dụng cụ đo trong túi bảo vệ (18).

### Dịch vụ hỗ trợ khách hàng và tư vấn sử dụng

Bộ phận phục vụ hàng sau khi bán của chúng tôi trả lời các câu hỏi liên quan đến việc bảo dưỡng và sửa chữa các sản phẩm cũng như phụ tùng thay thế của bạn. Sơ đồ mô tả và thông tin về phụ tùng thay thế cũng có thể tra cứu theo dưới đây: [www.bosch-pt.com](http://www.bosch-pt.com)

Đội ngũ tư vấn sử dụng của Bosch sẽ giúp bạn giải đáp các thắc mắc về sản phẩm và phụ kiện.

Trong tất cả các phản hồi và đơn đặt phụ tùng, xin vui lòng luôn luôn nhập số hàng hóa 10 chữ số theo nhãn của hàng hóa.

#### Việt Nam

CN CÔNG TY TNHH BOSCH VIỆT NAM TẠI TP.HCM

Tầng 14, Ngôi Nhà Đức, 33 Lê Duẩn

Phường Bến Nghé, Quận 1, Thành Phố Hồ Chí Minh

Tel.: (028) 6258 3690

Fax: (028) 6258 3692 - 6258 3694

Hotline: (028) 6250 8555

Email: [tuvankhachhang-pt@vn.bosch.com](mailto:tuvankhachhang-pt@vn.bosch.com)

[www.bosch-pt.com.vn](http://www.bosch-pt.com.vn)

[www.baohanhbosch-pt.com.vn](http://www.baohanhbosch-pt.com.vn)

#### Xem thêm địa chỉ dịch vụ tại:

[www.bosch-pt.com/serviceaddresses](http://www.bosch-pt.com/serviceaddresses)

## Vận chuyển

Pin Li-Ion được khuyến nghị là đối tượng phải tuân theo các quy định của Pháp Luật về Hàng Hóa Nguy Hiểm. Người sử dụng có thể vận chuyển pin hợp khối bằng đường bộ mà không cần thêm yêu cầu nào khác.

Khi được vận chuyển thông qua bên thứ ba (vd. vận chuyển bằng đường hàng không hay đại lý giao nhận), phải tuân theo các yêu cầu đặc biệt về đóng gói và dán nhãn. Phải tham vấn chuyên gia về hàng hóa nguy hiểm khi chuẩn bị gói hàng.

Chỉ gửi pin hợp khối khi vỏ ngoài không bị hư hỏng. Dán băng keo hay che kín các điểm tiếp xúc hở và đóng gói pin hợp khối theo cách sao cho pin không thể xê dịch khi nằm trong bao bì. Ngoài ra, xin vui lòng chấp hành các quy định chi tiết có thể được bổ sung thêm của quốc gia.

## Sự thải bỏ



Máy đo, ắc quy/pin, phụ kiện và bao bì cần được tái sử dụng theo quy định về môi trường.



Không vứt dụng cụ đo và pin/ắc quy cùng trong rác thải của gia đình!

### Pin:

#### Li-Ion:

Tuân thủ những hướng dẫn trong phần vận chuyển (xem „Vận chuyển“, Trang 251).

## Phụ kiện

Hãy tìm phụ kiện trên trang web của Bosch bằng liên kết đã cho



BA 3.7V 1.0Ah A (19)  
1 608 M00 C5D

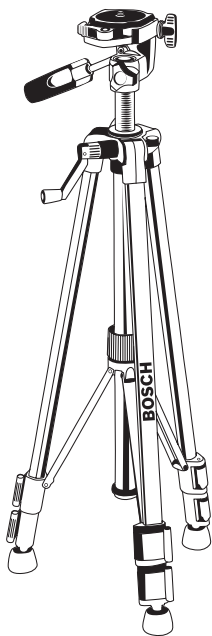

Giá chân BT 150 (25)  
0 601 096 B00

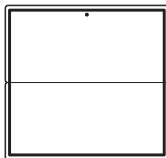

Cọc tẩm đích laser (26)  
2 607 001 391



Kính nhìn tia laser (màu xanh lá cây) (27)

1 608 M00 05J